

DS-1402

13/12th Generation Intel Core Series Processors, High Performance, Expandable and Modular Rugged Embedded Computer with 2x PCI/PCIe Expansion Slot

CONTROL
ENGINEERING
2024
PRODUCT
OF THE YEAR
Bronze
Award

VISION
SYSTEMS DESIGN
2024
Innovators
Awards
BRONZE HONOREE



High Performance | Highly Expandable

DS-1402, 12th Gen. Intel Alder Lake-S Rugged Embedded Computer



Overview

[CONTACT](#)

The DS-1402 is a high-performance, expandable, and rugged embedded computer, boasting outstanding performance as well as rich industrial I/O interfaces and robust functionalities. To meet various application needs, it has dual PCI/PCIe expansion capability and it can also flexibly expand the required I/O and specific functions through Cincoze's unique CMI, CFM, and MEC modules. Moreover, the DS-1402 has passed multiple international certifications, ensuring stable and reliable performance in diverse harsh environments. It is an ideal choice for manufacturing and railway applications.

Key Features

- Intel® 13/12th Gen Raptor Lake-S/Alder Lake-S Core™ i9/i7/i5/i3 Processors (max 65 W TDP)
- 2x DDR5 SO-DIMM Sockets, Supports ECC/non ECC type Memory, Up to 4800MHz, 64GB
- 2x GbE LAN and optional 2x 10GbE LAN
- 2x 2.5" SATA storage, 3x mSATA sockets, 1x M.2 key M for NVMe SSD
- 2x PCI/PCIe expansion slots
- Optional CMI modules for I/O expansion
- Optional CFM modules for ignition sensing & PoE
- Wide operating temperature -40°C to 70°C
- MIL-STD-810G military standard and EN50155 (EN 50121-3-2 only)
- Safety Standard: UL, cUL, CB, IEC, EN 62368-1
- Support Intel® OpenVINO™ Dev Kit
- Intel® ESDQ (Edge Software Device Qualification) Certified: the Edge Insights for AMR software package

Certifications



Rapid Processing and Inference

The DS-1402 supports 13/12th gen Intel® Core™ i9/i7/i5/i3 (Raptor Lake-S/Alder Lake-S) processors based on the Intel 7 process, with up to 24 cores (8P + 16E) and 32 threads, delivering more than 1.35x the speed of Comet Lake-S platform. The Intel® Xe architecture of the UHD 770 graphics chip boosts GPU image classification inference performance to 2.8x the speed of Comet Lake-S, providing the processing performance needed for AI and edge computing.

CPU Performance

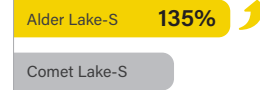

Alder Lake-S

GPU Image Classification Inference Performance



Industrial I/O and Modular Expansion

The DS-1402 offers a vast array of industrial-focused I/O including up to 2x GbE LAN, 6x USB 3.2, and 2x USB 2.0, 2x RS232/422/485, 2x 2.5" SATA, 3x mSATA, 1x M.2 key M for NVMe SSD, 2x SIM card slots, 3x full-size Mini-PCIe and quad independent displays (DisplayPort, HDMI, VGA). It also features modular expansion through Cincoze's CMI/CFM modules, adding additional I/O or other functionality such as high-speed 10GbE LAN, PoE, and IGN (power ignition sensing).

PCI/PCIe Add-on Cards

The DS-1402 accommodates dual PCI/PCIe expansion slots. It can support a maximum of one 110W add-on card with dimensions of 111 x 235 mm. This flexible slot allows integration of I/O, GPU, image capture, data acquisition, and motion control cards to suit specific application needs.



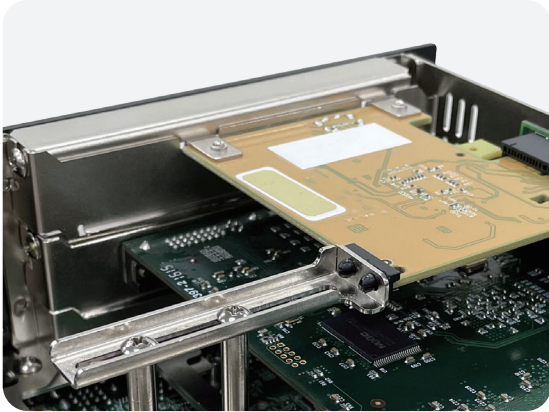

Adjustable PCIe Card Retainer

A patented adjustable PCIe card retainer can securely fasten add-on cards. This unique design effectively prevents the cards from loosening due to vibrations in high-vibration environments, ensuring the stable operation of the system.

Patent No. I773359

Robust and Reliable

The DS-1402 is built tough, reflected in its industrial-grade protection design and industry certifications in different fields. In addition to features such as wide temperature (-40 - 70°C), wide voltage input (9 - 48 VDC), overvoltage, overcurrent, and ESD protection, it also complies with the US military shock vibration standard MIL-STD-810G. Product safety and reliability are further ensured with internationally recognized UL 62368-1 safety certification. For more secure railway computing, it also passes the EMC EN 50121-3-2 standard in EN 50155.

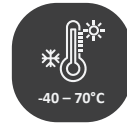

Specifications

Model Name	DS-1402
System	
Processor	<ul style="list-style-type: none"> 13th Generation Intel® Raptor Lake-S Series CPU: <ul style="list-style-type: none"> - Intel® Core™ i9-13900E 24 Cores Up to 5.2 GHz, TDP 65W - Intel® Core™ i7-13700E 16 Cores Up to 5.1 GHz, TDP 65W - Intel® Core™ i5-13500E 14 Cores Up to 4.6 GHz, TDP 65W - Intel® Core™ i5-13400E 10 Cores Up to 4.6 GHz, TDP 65W - Intel® Core™ i3-13100E 4 Cores Up to 4.4 GHz, TDP 60W - Intel® Core™ i9-13900TE 24 Cores Up to 5.0 GHz, TDP 35W - Intel® Core™ i7-13700TE 16 Cores Up to 4.8 GHz, TDP 35W - Intel® Core™ i5-13500TE 14 Cores Up to 4.5 GHz, TDP 35W - Intel® Core™ i3-13100TE 4 Cores Up to 4.1 GHz, TDP 35W 12th Generation Intel® Alder Lake-S Series CPU: <ul style="list-style-type: none"> - Intel® Core™ i9-12900E 16 Cores Up to 5 GHz, TDP 65W - Intel® Core™ i7-12700E 12 Cores Up to 4.8 GHz, TDP 65W - Intel® Core™ i5-12500E 6 Cores Up to 4.5 GHz, TDP 65W - Intel® Core™ i3-12100E 4 Cores Up to 4.2 GHz, TDP 60W - Intel® Core™ i9-12900TE 16 Cores Up to 4.8 GHz, TDP 35W - Intel® Core™ i7-12700TE 12 Cores Up to 4.7 GHz, TDP 35W - Intel® Core™ i5-12500TE 6 Cores Up to 4.3 GHz, TDP 35W - Intel® Core™ i3-12100TE 4 Cores Up to 4.0 GHz, TDP 35W - Intel® Pentium® G7400E 2 Cores Up to 3.6 GHz, TDP 46W - Intel® Pentium® G7400TE 2 Cores Up to 3.0 GHz, TDP 35W - Intel® Celeron® G6900E 2 Cores Up to 3.0 GHz, TDP 46W - Intel® Celeron® G6900TE 2 Cores Up to 2.4 GHz, TDP 35W
Chipset	<ul style="list-style-type: none"> Intel R680E Chipset
Memory	<ul style="list-style-type: none"> 2x DDR5 4800 MHz SO-DIMM Socket, Supports Un-buffered and ECC Type, Up to 64GB
BIOS	<ul style="list-style-type: none"> AMI BIOS
Graphics	
Graphics Engine	<ul style="list-style-type: none"> Integrated Intel® UHD Graphics 770: Core™ i9/i7/i5 Integrated Intel® UHD Graphics 730: Core™ i3 Integrated Intel® UHD Graphics 710: Pentium®/Celeron®
Maximum Display Output	<ul style="list-style-type: none"> Supports Quad Independent Display
VGA	<ul style="list-style-type: none"> 1x VGA Connector : 1920 x 1080@60Hz
DP	<ul style="list-style-type: none"> 2x DP Connector : 4096 x 2304@60Hz * Verified maximum DP resolution: 3840x2160 @60Hz
HDMI	<ul style="list-style-type: none"> 1x HDMI Connector : 4096x2160@30Hz * Verified maximum resolution: 3840x2160 @30Hz
Audio	
Audio Codec	<ul style="list-style-type: none"> Realtek® ALC888, High Definition Audio
Line-out	<ul style="list-style-type: none"> 1x Line-out, Phone Jack 3.5mm
Mic-in	<ul style="list-style-type: none"> 1x Mic-in, Phone Jack 3.5mm
I/O	
LAN	<ul style="list-style-type: none"> 2x GbE LAN, RJ45 <ul style="list-style-type: none"> - GbE1: Intel® I219 - GbE2: Intel® I210
COM	<ul style="list-style-type: none"> 2x RS-232/422/485 with Auto Flow Control (Supports 5V/12V), DB9
USB	<ul style="list-style-type: none"> 2 x USB 3.2 Gen2x1 (10Gbps), Type A 4 x USB 3.2 Gen1x1 (5Gbps), Type A 2 x USB 2.0 (480Mbps), Type A
PS/2	<ul style="list-style-type: none"> 1 x PS/2, 6 Pin Mini-DIN Female Connector

Storage	
SSD/HDD	<ul style="list-style-type: none"> • 1x 2.5" Front Accessible SATA HDD/SSD Bay (SATA 3.0) • 1x 2.5" Internal SATA HDD/SSD Bay (SATA 3.0)
mSATA	<ul style="list-style-type: none"> • 3x mSATA Socket (SATA 3.0, shared by Mini-PCIe socket)
M.2 SSD	<ul style="list-style-type: none"> • 1x M.2 Key M Type 2280 Socket, Support PCIe Gen3 x4 NVMe SSD or SATA SSD (SATA 3.0)
RAID	<ul style="list-style-type: none"> • Support RAID 0/1/5/10
Expansion	
PCI Express	<ul style="list-style-type: none"> • 2x PCI/PCIe Expansion Slot with Optional Riser Card * Supports maximum dimensions of add-on card (H x L) : 111 x 235 mm
Mini PCI Express	<ul style="list-style-type: none"> • 3x Full-size Mini-PCIe Socket
SIM Socket	<ul style="list-style-type: none"> • 2x SIM Socket
CMI (Combined Multiple I/O) Interface	<ul style="list-style-type: none"> • 2x High Speed CMI Interface for optional CMI Module Expansion • 2x Low Speed CMI Interface for optional CMI Module Expansion
CFM (Control Function Module) Interface	<ul style="list-style-type: none"> • 1x CFM IGN Interface for optional CFM-IGN Module Expansion
Other Function	
External FAN Connector	<ul style="list-style-type: none"> • 1x External FAN Connector, 4-pin Terminal Block (Support Smart Fan by BIOS)
Power Ignition Sensing	<ul style="list-style-type: none"> • Support Power Ignition Sensing Function with Delay Time Management and Selectable 12V/24V (With Optional CFM Module)
Clear CMOS Switch	<ul style="list-style-type: none"> • 1x Clear CMOS Switch
Reset Button	<ul style="list-style-type: none"> • 1x Reset Button
Instant Reboot	<ul style="list-style-type: none"> • Support 0.2sec Instant Reboot Technology
Watchdog Timer	<ul style="list-style-type: none"> • Software Programmable Supports 256 Levels System Reset
Power	
Power Button	<ul style="list-style-type: none"> • 1x ATX Power On/Off Button
Power Mode Switch	<ul style="list-style-type: none"> • 1x AT/ATX Mode Switch
Power Input	<ul style="list-style-type: none"> • 9 - 48VDC, 3-pin Terminal Block
Remote Power On/Off	<ul style="list-style-type: none"> • 1x Remote Power On/Off, 2-pin Terminal Block
Remote Power LED	<ul style="list-style-type: none"> • 1x Remote Power LED, 2-pin Terminal Block
Physical	
Dimension(W x D x H)	<ul style="list-style-type: none"> • 227 x 261 x 128 mm
Weight Information	<ul style="list-style-type: none"> • 5.44 kg
Mechanical Construction	<ul style="list-style-type: none"> • Extruded Aluminum with Heavy Duty Metal
Mounting	<ul style="list-style-type: none"> • Wall
Physical Design	<ul style="list-style-type: none"> • Fanless Design • Cableless Design • Jumper-less Design • Unibody Design
Reliability & Protection	
Reverse Power Input Protection	<ul style="list-style-type: none"> • Yes
Over Voltage Protection	<ul style="list-style-type: none"> • Protection Range: 51~58V • Protection Type: shut down operating voltage, re-power on at the preset level to recover
Over Current Protection	<ul style="list-style-type: none"> • 15A

CMOS Battery Backup	<ul style="list-style-type: none"> • SuperCap Integrated for CMOS Battery Maintenance-free Operation
MTBF	<ul style="list-style-type: none"> • 371,274 Hours - Database: Telcordia SR-332 Issue3, Method 1, Case 3
Operating System	
Windows	<ul style="list-style-type: none"> • Windows®11, Windows®10
Linux	<ul style="list-style-type: none"> • Ubuntu 22.04
Environment	
Operating Temperature	<ul style="list-style-type: none"> • 35W TDP Processor: -40°C to 70°C • 65W TDP Processor: -40°C to 50°C (With External Fan Kit) - With extended temperature peripherals; Ambient with air flow - According to IEC60068-2-1, IEC60068-2-2, IEC60068-2-14
Storage Temperature	<ul style="list-style-type: none"> • -40°C to 85°C
Relative Humidity	<ul style="list-style-type: none"> • 95%RH @ 70°C (non-Condensing)
Shock	<ul style="list-style-type: none"> • MIL-STD-810G
Vibration	<ul style="list-style-type: none"> • MIL-STD-810G
EMC	<ul style="list-style-type: none"> • CE, UKCA, FCC, ICES-003 Class A • EN 50155 (EN 50121-3-2 Only)
EMI	<ul style="list-style-type: none"> • CISPR 32 Conducted & Radiated: Class A • EN/BS EN 50121-3-2 Conducted & Radiated: Class A • EN/BS EN IEC 61000-3-2 Harmonic current emissions: Class A • EN/BS EN61000-3-3 Voltage fluctuations & flicker • FCC 47 CFR Part 15B, ICES-003 Conducted & Radiated: Class A
EMS	<ul style="list-style-type: none"> • EN/IEC 61000-4-2 ESD: Contact: 6 kV; Air: 8 kV • EN/IEC 61000-4-3 RS: 80 MHz to 1000 MHz: 20 V/m • EN/IEC 61000-4-4 EFT: AC Power: 2 kV; Signal: 2 kV • EN/IEC 61000-4-5 Surges: AC Power: 2 kV • EN/IEC 61000-4-6 CS: 10V • EN/IEC 61000-4-8 PFMF: 50 Hz, 1A/m • EN/IEC 61000-4-11 Voltage Dips & Voltage Interruptions: 0.5 cycles at 50 Hz
Safety	<ul style="list-style-type: none"> • UL, cUL, CB, IEC, EN 62368-1

External Layout

Front I/O

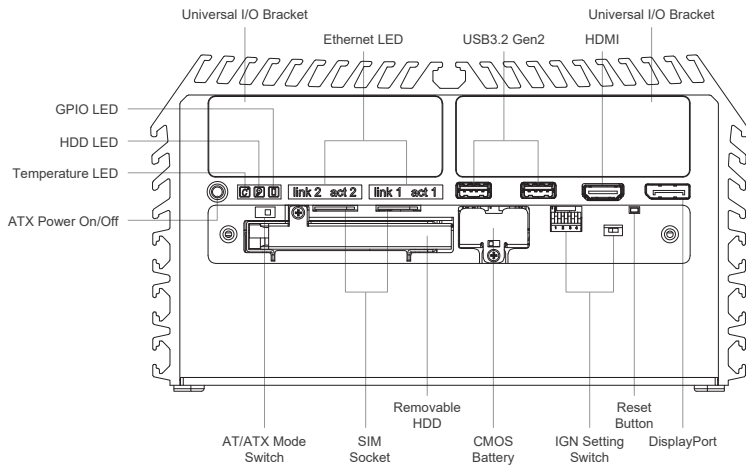

Rear I/O

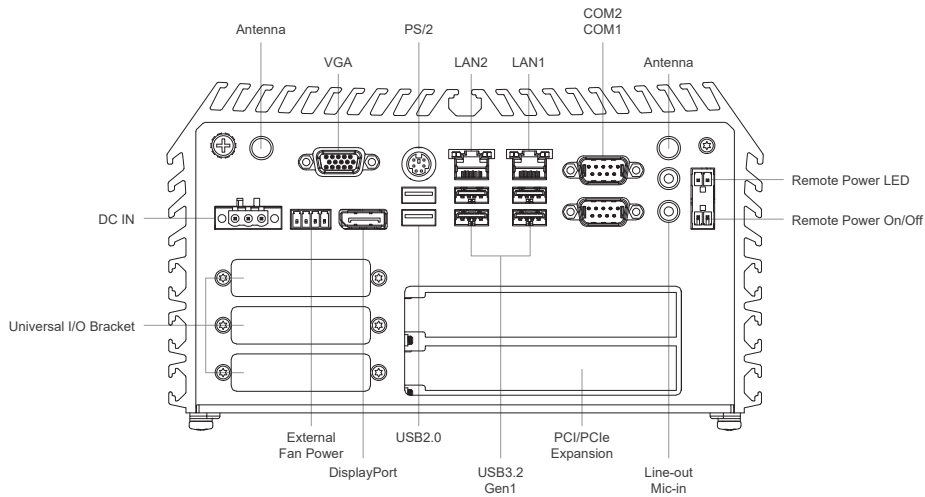

Dimensions

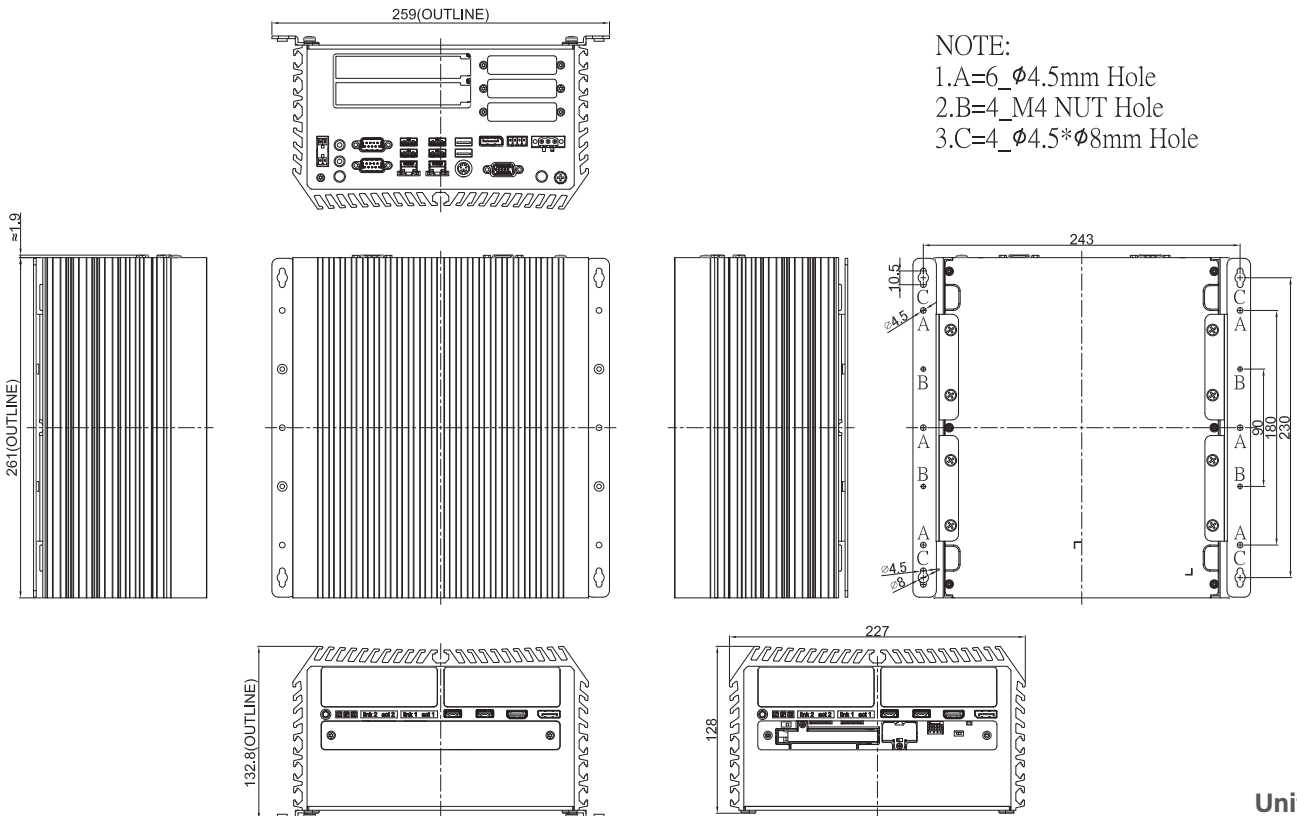

Unit: mm

Ordering Information

Available Models

Model No.	Description
DS-1402-R10	13/12th Generation Intel Core Series Processors, High Performance, Expandable and Modular Rugged Embedded Computer with 2x PCI/PCIe Expansion Slot

Package Checklist

• DS-1402 Embedded System x1	• Heatsink Pack x1
• Wall Mounting Kit x1	• Screw Pack x1
• Power Terminal Block Connector x 1	• Remote Function Terminal Block Connector x 2
• Fan Terminal Block Connector x 1	









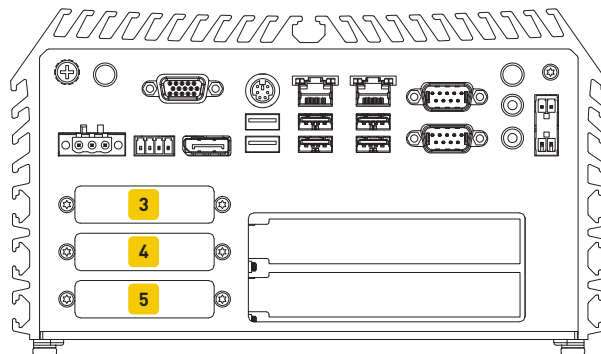
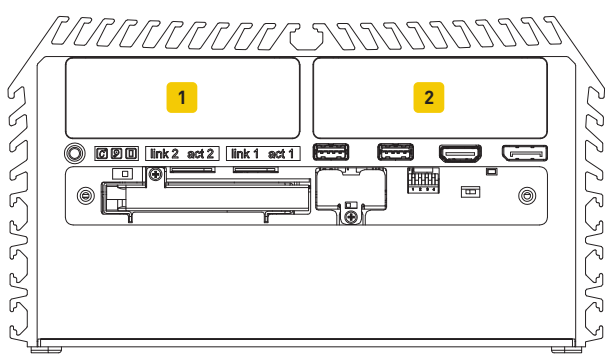

Optional Modules and Accessories

Model No.	Description
CMI-LAN01-R12	CMI Module with 4x RJ45 Intel I210 GbE LAN Ports
CMI-M12LAN01-R12	CMI Module with 4x M12 Intel I210 GbE LAN Ports
CMI-XM12LAN01-R10	CMI Module with M12 X-Coded Connector, 4x Intel I210 GbE LAN Ports
CMI-10GLAN03-R10	CMI Module with 2x Intel X550 10GbE LAN, RJ45 Port
CMI-COM02	CMI Module with 4x RS232/422/485 Serial Ports
CMI-ICOM01	CMI Module with 4x Electrical Isolated RS-232 Serial Ports
CMI-DIO02	CMI Module with 16x Optical Isolated DIO (8 in/8 out)
MEC-LAN-M102-30	Mini-PCIe Module with 2x LAN Ports, 2x 30cm cable
MEC-USB-M102-30	Mini-PCIe Module with 2x USB 3.2 Gen1 Ports, 1x 30cm cable
MEC-COM-M212-DB9	Mini-PCIe Module with 2x RS-232 Serial Ports, 1x Standard DB9 Cable
UB1004	Universal Bracket with 4x DB9 Cutout
UB1010	Universal Bracket with 4x M12 Cutout
UB1012	Universal Bracket with 4x RJ45 Cutout
UB1018	Universal Bracket with DIO Cutout
UB1028	Universal Bracket with 2x RJ45 Cutout
UB1030-R10	Universal Bracket with 4x M12 X-Coded Cutout
UB0303	2x Universal Bracket each with 1x DB9 Cutout
UB0311	Universal Bracket with 2x RJ45 Cutout
UB0314	Universal Bracket with 2x USB Cutout
CFM-PoE03	CFM Module with PoE Control Function, Individual Port 25.5W
CFM-IGN101	CFM Module with Power Ignition Sensing Control Function, 12V/24V Selectable
RC-E8E8-R10	Riser Card with 2 x PCIe8 Slots
RC-E16E1-01	Riser Card with 1x PCIe16 and 1x PCIe1 Slots (PCIe x16 Slot Supports Dual Deck Add-on Card)
RC-E16PI-01	Riser Card with 1x PCIe16 and 1x PCI Slots (PCIe x16 Slot Supports Single Deck Add-on Card)
RC-PIPI-01	Riser Card with 2x PCI Slots

FAN-EX101	External Fan with 4pin Terminal Block Plug, Mounting Bracket, Support smart fan
FAN-UB100	Exhaling fan with 4pin Connector, Universal Bracket
FAN-UB101	Inhaling fan with 4pin Connector, Universal Bracket
GST120A24-CIN	Adapter AC/DC 24V 5A 120W with 3pin Terminal Block Plug and Tubes, Level VI
GST220A24-CIN	Adapter AC/DC 24V 9.2A 220W with 3pin Terminal Block Plug and Tubes, Level VI

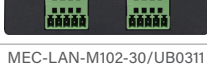
Optional Module Configuration

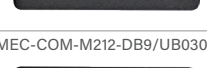

Model No.	Description	1	2	3	4	5
CMI-LAN01-R12/UB1012 	CMI Module with 4x Intel I210 GbE LAN, RJ45 Port / 1x Universal Bracket with 4x RJ45 Cutout	V	V	--	--	--
CMI-M12LAN01-R12/UB1010 	CMI Module with M12 Connector, 4x Intel GbE LAN / 1x Universal Bracket with 4x M12 Cutout	V	V	--	--	--
CMI-XM12LAN01-R10/UB1030-R10 	CMI Module with M12 X-Coded Connector, 4x Intel I210 GbE LAN Ports / Universal Bracket with 4x M12 X-Coded Cutout	V	V	--	--	--
CMI-10GLAN03-R10/UB1028 	CMI Module with 2x Intel X550 10GbE LAN, RJ45 Port / 1x Universal Bracket with 2x RJ45 Cutout	V	--	--	--	--
CMI-COM02/UB1004 	CMI Module with 4x RS232/422/485 Ports (Support 5V/12V) / 1x Universal Bracket with 4x DB9 Cutout	V	V	--	--	--
CMI-ICOM01/UB1004 	CMI Module with 4 x isolated RS232 / 1x Universal Bracket with 4x DB9 Cutout	V	V	--	--	--
CMI-DIO02/UB1018 	CMI Module with 16DIO (8in 8out) / 1x Universal Bracket with DIO Cutout	V	V	--	--	--
MEC-LAN-M102-30/UB0311 	Mini-PCIe Module with 2x LAN Ports, 2x 30cm cable / 1x Universal Bracket with 2x RJ45 Cutout	--	--	V	V	V
MEC-USB-M102-30/UB0314 	Mini-PCIe Module with 2x USB 3.2 Gen1 Ports, 1x 30cm cable, 1x Universal Bracket with 2x USB Cutout	--	--	V	V	V
MEC-COM-M212-DB9/UB0303 	Mini-PCIe Module with 2x RS-232 Ports, 1x Standard DB9 Cable / 2x Universal Bracket each with 1x DB9 Cutout	--	--	V	V	V

Remark:
Maximum one CMI-COM02 or CMI-ICOM01 module can be installed in this system.

V : Compatible