

***CHCOZE***

# DI-1200 Series

## User Manual



### **Rugged Embedded Computer**

12th Generation Intel® Core™ U Series High Performance, Compact and Modular Rugged Embedded Computer

# Contents

Preface.....	5
Revision .....	5
Copyright Notice .....	5
Acknowledgement .....	5
Disclaimer.....	5
Declaration of Conformity.....	5
Product Warranty Statement .....	6
Technical Support and Assistance .....	7
Conventions Used in this Manual .....	8
Safety Precautions.....	8
Package Checklist .....	9
Ordering Information .....	10
Chapter 1 Product Introductions .....	11
1.1 Overview .....	12
1.2 Hardware Specification .....	14
1.3 External Layout.....	16
1.3.1 Front .....	16
1.3.2 Rear .....	16
1.4 Dimensions.....	17
Chapter 2 Introduction to Switches & Connectors .....	18
2.1 Location of System Switches and Connectors.....	19
2.1.1 Top View .....	19
2.1.2 Bottom View.....	19
2.2 Switches and Connectors Definition .....	20
2.3 Definition of Switches .....	21
2.4 Definition of Connectors .....	22
2.5 Optional Module Pin Definition & Settings.....	26
2.5.1 CMI-COM05-R10 Module.....	26
2.5.2 CMI-DIO05-R10 Module.....	27
2.5.3 CFM-IGN102 Module .....	28
2.5.4 CMI-LAN01-R12 Module .....	28
2.5.5 CMI-M12LAN01-R12 Module.....	29
2.5.6 CMI-XM12LAN01-R10 Module.....	29
2.5.7 CMI-10GLAN04-R10 Module.....	29
Chapter 3 System Setup .....	30
3.1 Removing Top Cover.....	31
3.2 Installing SO-DIMM Memory .....	32
3.3 Installing M.2 Key B Module .....	33

3.3.1 M.2 Key B type 3052 .....	33
3.3.2 M.2 Key B type 3042 .....	34
3.4 Installing M.2 Key E Module.....	35
3.5 Installing Antenna(s) .....	38
3.6 Installing CPU Heatsink Thermal Pad .....	40
3.7 Installing Top Cover .....	41
3.8 Installing SATA Hard Drive .....	42
3.9 Installing SIM Card.....	44
3.10 Installing Wall Mount .....	45
3.11 Installing VESA Mount .....	46
3.12 Installing Side Mount .....	47
3.13 Installing DIN-Rail Mount .....	48
3.14 Installing External FAN .....	49
3.15 Installing CMI Modules .....	51
3.15.1 CMI-LAN01-R12/UB1512-R11 .....	51
3.15.2 CMI-M12LAN01-R12/UB1510-R11 .....	52
3.15.3 CMI-XM12LAN01-R10/UB1510-R11 .....	54
3.15.4 CMI-10GLAN04-R10/UB1528-R11 .....	56
3.15.5 CMI-COM05-R10/UB1503-R11 .....	60
3.15.6 CMI-DIO05-R10/UB1518-R10 .....	62
3.15.7 CMI-DP02/UB1506-R10 .....	63
3.15.8 CMI-HD04/UB1508-R10 .....	65
3.15.9 CMI-VGA02/UB1516-R10.....	67
3.16 Installing CFM Modules.....	69
3.16.1 CFM-IGN102.....	69
3.16.2 CFM-PoE06-R10 .....	70
Chapter 4 BIOS Setup.....	73
4.1 BIOS Introduction.....	74
4.2 Main Setup.....	75
4.3 Advanced Setup .....	75
4.3.1 CPU Configuration.....	76
4.3.2 SATA Configuration.....	77
4.3.3 PCH-FW Configuration .....	77
4.3.4 Trusted Computing Settings .....	78
4.3.5 ACPI Settings .....	79
4.3.6 F81966 Super IO Configuration.....	80
4.3.7 Hardware Monitor .....	81
4.3.8 S5 RTC Wake Settings.....	82
4.3.9 Serial Port Console Redirection.....	83
4.3.10 USB Configuration .....	83

4.3.11 Network Stack Configuration .....	84
4.3.12 CSM Configuration .....	84
4.3.13 NVMe Configuration .....	85
4.4 Chipset Setup .....	85
4.4.1 System Agent (SA) Configuration .....	86
4.4.2 PCH-IO Configuration .....	88
4.5 Security Setup .....	90
4.6 Boot Setup.....	92
4.7 Save & Exit.....	93
4.8 MEBx .....	94
Chapter 5 Product Application .....	97
5.1 Where to download drivers? .....	98
5.2 Where to find the technical documents? .....	98

# Preface

## Revision

Revision	Description	Date
1.00	First Release	2024/01/31
1.10	OS Spec Updated	2024/04/26
1.11	UL Certification Added	2024/06/18
1.12	Installation Note for M.2 Key B and Key E Modules Added	2024/10/15

## Copyright Notice

© 2024 by Cincoze Co., Ltd. All rights are reserved. No parts of this manual may be copied, modified, or reproduced in any form or by any means for commercial use without the prior written permission of Cincoze Co., Ltd. All information and specification provided in this manual are for reference only and remain subject to change without prior notice.

## Acknowledgement

Cincoze is a registered trademark of Cincoze Co., Ltd. All registered trademarks and product names mentioned herein are used for identification purposes only and may be trademarks and/or registered trademarks of their respective owners.

## Disclaimer

This manual is intended to be used as a practical and informative guide only and is subject to change without notice. It does not represent a commitment on the part of Cincoze. This product might include unintentional technical or typographical errors. Changes are periodically made to the information herein to correct such errors, and these changes are incorporated into new editions of the publication.

## Declaration of Conformity



### FCC

This equipment has been tested and found to comply with the limits for a Class A digital device, pursuant to Part 15 of the FCC Rules. These limits are designed to provide reasonable protection against harmful interference when the equipment is operated in a commercial environment. This equipment generates, uses, and can radiate radio frequency energy and, if not installed and used in accordance with the

instruction manual, may cause harmful interference to radio communications. Operation of this equipment in a residential area is likely to cause harmful interference in which case the user will be required to correct the interference at his own expense.



#### **CE**

The product(s) described in this manual complies with all application European Union (CE) directives if it has a CE marking. For computer systems to remain CE compliant, only CE-compliant parts may be used. Maintaining CE compliance also requires proper cable and cabling techniques.



#### **UL**

A product that carries the “UL Listed” approval mark means that the product has been tested by UL to nationally recognized Safety Standards and has been found to be free from reasonably foreseeable risk of fire, electric shock and related hazards.

## **Product Warranty Statement**

### **Warranty**

Cincoze products are warranted by Cincoze Co., Ltd. to be free from defect in materials and workmanship for 2 years from the date of purchase by the original purchaser. During the warranty period, we shall, at our option, either repair or replace any product that proves to be defective under normal operation. Defects, malfunctions, or failures of the warranted product caused by damage resulting from natural disasters (such as by lightning, flood, earthquake, etc.), environmental and atmospheric disturbances, other external forces such as power line disturbances, plugging the board in under power, or incorrect cabling, and damage caused by misuse, abuse, and unauthorized alteration or repair, and the product in question is either software, or an expendable item (such as a fuse, battery, etc.), are not warranted.

### **RMA**

Before sending your product in, you will need to fill in Cincoze RMA Request Form and obtain an RMA number from us. Our staff is available at any time to provide you with the most friendly and immediate service.

#### **■ RMA Instruction**

- Customers must fill in Cincoze Return Merchandise Authorization (RMA) Request Form and obtain an RMA number prior to returning a defective product to Cincoze for service.
- Customers must collect all the information about the problems encountered and note anything abnormal and describe the problems on the “Cincoze Service Form” for the RMA number apply process.
- Charges may be incurred for certain repairs. Cincoze will charge for repairs to products whose warranty period has expired. Cincoze will also charge for repairs to

products if the damage resulted from acts of God, environmental or atmospheric disturbances, or other external forces through misuse, abuse, or unauthorized alteration or repair. If charges will be incurred for a repair, Cincoze lists all charges, and will wait for customer's approval before performing the repair.

- Customers agree to ensure the product or assume the risk of loss or damage during transit, to prepay shipping charges, and to use the original shipping container or equivalent.
- Customers can be sent back the faulty products with or without accessories (manuals, cable, etc.) and any components from the system. If the components were suspected as part of the problems, please note clearly which components are included. Otherwise, Cincoze is not responsible for the devices/parts.
- Repaired items will be shipped along with a "Repair Report" detailing the findings and actions taken.

### **Limitation of Liability**

Cincoze' liability arising out of the manufacture, sale, or supplying of the product and its use, whether based on warranty, contract, negligence, product liability, or otherwise, shall not exceed the original selling price of the product. The remedies provided herein are the customer's sole and exclusive remedies. In no event shall Cincoze be liable for direct, indirect, special or consequential damages whether based on contract of any other legal theory.

### **Technical Support and Assistance**

1. Visit the Cincoze website at [www.cincoze.com](http://www.cincoze.com) where you can find the latest information about the product.
2. Contact your distributor or our technical support team or sales representative for technical support if you need additional assistance. Please have following information ready before you call:
  - Product name and serial number
  - Description of your peripheral attachments
  - Description of your software (operating system, version, application software, etc.)
  - A complete description of the problem
  - The exact wording of any error messages

## Conventions Used in this Manual



**WARNING**  
(AVERTIR)

This indication alerts operators to an operation that, if not strictly observed, may result in severe injury.

(Cette indication avertit les opérateurs d'une opération qui, si elle n'est pas strictement observée, peut entraîner des blessures graves.)



**CAUTION**  
(ATTENTION)

This indication alerts operators to an operation that, if not strictly observed, may result in safety hazards to personnel or damage to equipment.

(Cette indication avertit les opérateurs d'une opération qui, si elle n'est pas strictement observée, peut entraîner des risques pour la sécurité du personnel ou des dommages à l'équipement.)



**NOTE**  
(NOTE)

This indication provides additional information to complete a task easily.

(Cette indication fournit des informations supplémentaires pour effectuer facilement une tâche.)

## Safety Precautions

Before installing and using this device, please note the following precautions.

1. Read these safety instructions carefully.
2. Keep this User's Manual for future reference.
3. Disconnect this equipment from any AC outlet before cleaning.
4. For plug-in equipment, the power outlet socket must be located near the equipment and must be easily accessible.
5. Keep this equipment away from humidity.
6. Put this equipment on a reliable surface during installation. Dropping it or letting it fall may cause damage.
7. Make sure the voltage of the power source is correct before connecting the equipment to the power outlet.
8. Use a power cord that has been approved for using with the product and that it matches the voltage and current marked on the product's electrical range label. The voltage and current rating of the cord must be greater than the voltage and current rating marked on the product.
9. Position the power cord so that people cannot step on it. Do not place anything over the power cord.
10. All cautions and warnings on the equipment should be noted.
11. If the equipment is not used for a long time, disconnect it from the power source to avoid damage by transient overvoltage.
12. Never pour any liquid into an opening. This may cause fire or electrical shock.



13. Never open the equipment. For safety reasons, the equipment should be opened only by qualified service personnel.  
If one of the following situations arises, get the equipment checked by service personnel:
  - The power cord or plug is damaged.
  - Liquid has penetrated into the equipment.
  - The equipment has been exposed to moisture.
  - The equipment does not work well, or you cannot get it work according to the user's manual.
  - The equipment has been dropped and damaged.
  - The equipment has obvious signs of breakage.
14. CAUTION: Risk of Explosion if Battery is replaced by an Incorrect Type. Dispose of Used Batteries According to the Instructions.  
ATTENTION: Risque d'explosion si la batterie est remplacée par un type incorrect. Mettre au rebus les batteries usagées selon les instructions.
15. Equipment intended only for use in a RESTRICTED ACCESS AREA.
16. Output of the external power source shall be complied with ES1, PS3 requirements, output rating between 9-48 VDC, minimum 5.9-1.2A, with minimum rated maximum ambient temperature 70°C, and has to be evaluated according to UL/IEC/EN 60950-1 and/or UL/IEC/EN 62368-1. If need further assistance, please contact Cincoze for further information.
17. Ensure to connect the power cord of power adapter to a socket-outlet with earthing connection.
18. Dispose of used battery promptly. Keep away from children. Do not disassemble and do not dispose of in fire.

## Package Checklist

Before installation, please ensure all the items listed in the following table are included in the package.

Item	Description	Q'ty
1	DI-1200 Embedded Computer	1
2	CPU Thermal Pad	1
3	Screw Pack	1
4	Wall Mounting Kit	1
5	Power Terminal Block Connector	1
6	Remote Power On/Off + Remote Power LED Connector	1
7	Fan Terminal Block Connector	1
8	M.2 Key B Type 3052 to 3042 Adapter Bracket	1

*Note: Notify your sales representative if any of the above items are missing or damaged.*

## Ordering Information

<b>Model No.</b>	<b>Description</b>
DI-1200-i7-R10	12th Generation Intel Core i7-1265UE High Performance, Compact and Modular Rugged Embedded Computer
DI-1200-i5-R10	12th Generation Intel Core i5-1245UE High Performance, Compact and Modular Rugged Embedded Computer
DI-1200-i3-R10	12th Generation Intel Core i3-1215UE High Performance, Compact and Modular Rugged Embedded Computer



# **Chapter 1**

## **Product Introductions**

# 1.1 Overview

The DI-1200, with a 12th generation Intel® Core™ U-series (Alder Lake-P Platform) processor, provides outstanding performance and boasts a low power consumption of 15W. The compact DI-1200 offers rich I/O interfaces and expansion options, meeting the requirements for high-performance, rugged embedded computers used in confined spaces. It suits for industrial automation, warehousing and logistics, transportation, environmental monitoring, and IoT applications.

## Key Features

- Onboard 12th Intel® Alder Lake-P U-Series Core™ i7/i5/i3 Processors
- 1 x DDR5 SO-DIMM Sockets, Supports up to 4800MHz 32GB Memory
- Quad Independent Display (2x DP/HDMI/CMI Display)
- 1x M.2 Key E Type 2230 Socket for Wireless/Intel CNVi Module Expansion
- 1x M.2 Key B Type 3042/3052 Socket for 5G/Storage/Add-on Card Expansion
- CMI Technology for Optional I/O Module Expansions
- CFM Technology for Power Ignition Sensing Function & PoE
- Wide Operating Temperature -40°C to 70°C
- Safety Certification: UL, cUL, CB, IEC, EN 62368-1

## Certification



### High Performance & Power Saving

The DI-1200 supports the 12th generation Core™ i7/i5/i3 U-series (Alder Lake-P) processor based on the Intel® 7 process. Its exceptional processing performance and ultra-low power consumption of just 15W, make it highly suitable for mobile devices limited by battery capacity.

**15 Watts**  
Low Power Consumption



### Smaller than A5

The DI-1200 has a footprint smaller than a sheet of A5 paper, with dimensions of only 203 x 142 x 66.8 mm. It is ideal for mobile devices such as AGVs and AMRs, tight spaces in vehicles, or small cabinets in factories.

## High-speed I/O

The DI-1200 offers a range of high-speed I/O, including LAN (10GbE, 2.5GbE, 1GbE), USB 3.2 (10Gbps, 5Gbps), USB 2.0, and more, making data and image transmission faster and allowing easy connection to various high-speed devices.



## Comprehensive Wireless Options

The DI-1200 has one M.2 Key E slot and one M.2 Key B slot, supporting a full range of wireless transmission options, including GSM, GNSS, Wi-Fi, and Bluetooth. It also supports the Intel CNVi module, meeting diverse transmission needs.

## Quick Hard Drive Removal

Mobile devices must allow quick access to data. The DI-1200 features a hot-swappable 2.5-inch SATA HDD/SSD slot in the front panel of the chassis, making it easy to remove the hard drive and access the data on it.

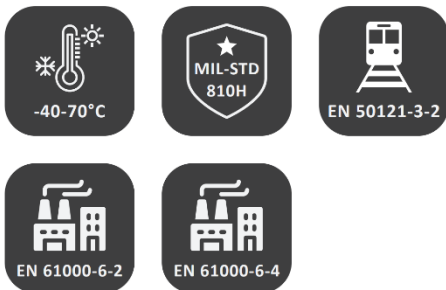

## Secure & Rugged

The DI-1200 showcases its ruggedness and industrial-grade protections through multiple industry certifications. It complies with industrial EMC standards (IEC 61000-6-2 and IEC 61000-6-4), ensuring reliable operation in external electromagnetic interference from surrounding devices. The DI-1200 also meets the U.S. military standard, MIL-STD-810H, ensuring stable operation under extreme shock and vibration conditions.

## 1.2 Hardware Specification

Model Name	DI-1200
<b>System</b>	
Processor	<ul style="list-style-type: none"> <li>Onboard 12th Intel® Alder Lake-P U-Series CPU:               <ul style="list-style-type: none"> <li>-Intel® Core™ i7-1265UE 10 Cores Up to 4.70 GHz, TDP 15W</li> <li>-Intel® Core™ i5-1245UE 10 Cores Up to 4.40 GHz, TDP 15W</li> <li>-Intel® Core™ i3-1215UE 6 Cores Up to 4.40 GHz, TDP 15W</li> </ul> </li> </ul>
Memory	<ul style="list-style-type: none"> <li>1x DDR5 SO-DIMM Socket, Supports Un-buffered and non-ECC Type, Up to 32GB</li> </ul>
BIOS	<ul style="list-style-type: none"> <li>AMI BIOS</li> </ul>
<b>Graphics</b>	
Graphics Engine	<ul style="list-style-type: none"> <li>Integrated Intel® Iris® Xe Graphics: Core™ i7-1265UE, i5-1245UE</li> <li>Integrated Intel® UHD Graphics: Core™ i3-1215UE</li> </ul>
Maximum Display Output	<ul style="list-style-type: none"> <li>Supports Quad Independent Display</li> </ul>
HDMI	<ul style="list-style-type: none"> <li>1x HDMI Connector (3840 x 2160@60Hz)</li> </ul>
DP	<ul style="list-style-type: none"> <li>2x DisplayPort Connector (3840 x 2160@60Hz)</li> </ul>
CMI Display	<ul style="list-style-type: none"> <li>1x CMI Interface for Optional CMI-DP/CMI-HDMI/CMI-VGA Module Expansion</li> </ul>
<b>Audio</b>	
Audio Codec	<ul style="list-style-type: none"> <li>Realtek® ALC888, High Definition Audio</li> </ul>
Line-out	<ul style="list-style-type: none"> <li>1x Line-out, Phone Jack 3.5mm</li> </ul>
Mic-in	<ul style="list-style-type: none"> <li>1x Mic-in, Phone Jack 3.5mm</li> </ul>
<b>I/O</b>	
LAN	<ul style="list-style-type: none"> <li>2x 2.5 GbE LAN, RJ45               <ul style="list-style-type: none"> <li>- GbE1: Intel® I225</li> <li>- GbE2: Intel® I225</li> </ul> </li> </ul>
COM	<ul style="list-style-type: none"> <li>2x RS-232/422/485 with Auto Flow Control Support 5V/12V, DB9</li> </ul>
USB	<ul style="list-style-type: none"> <li>1x 10Gbps USB 3.2 Gen2x1, Type A</li> <li>2x 5Gbps USB 3.2 Gen1, Type A</li> <li>3x 480 Mbps USB 2.0, Type A</li> </ul>
<b>Storage</b>	
SSD/HDD	<ul style="list-style-type: none"> <li>1x 2.5" SATA HDD/SSD Bay (SATA 3.0)</li> </ul>
M.2 SSD	<ul style="list-style-type: none"> <li>1 x M.2 SSD shared by M.2 Key B Type 3052 Socket</li> </ul>
RAID	<ul style="list-style-type: none"> <li>Support RAID 0/1</li> </ul>
<b>Expansion</b>	
M.2 Key E Socket	<ul style="list-style-type: none"> <li>1x M.2 Key E Type 2230 Socket, Support Wireless / Intel CNVi Module Expansion</li> </ul>
M.2 Key B Socket	<ul style="list-style-type: none"> <li>1x M.2 Key B Type 3042/3052 Socket, Support 5G / Storage / Add-on Card Expansion</li> </ul>
SIM Socket	<ul style="list-style-type: none"> <li>2x Front Accessible SIM Socket</li> </ul>
CMI (Combined Multiple I/O) Interface	<ul style="list-style-type: none"> <li>1x CMI Interface for optional CMI-LAN Module Expansion</li> <li>1x CMI Interface for optional CMI-Display / CMI-COM / CMI-DIO Module Expansion</li> </ul>
CFM (Control Function Module) Interface	<ul style="list-style-type: none"> <li>1x CFM IGN Interface for optional CFM-IGN Module Expansion</li> </ul>
<b>Other Function</b>	
External FAN Connector	<ul style="list-style-type: none"> <li>1x External FAN Connector, 4-pin Terminal Block (Support Smart Fan by BIOS)</li> </ul>
Clear CMOS Switch	<ul style="list-style-type: none"> <li>1x Clear CMOS Switch</li> </ul>
Reset Button	<ul style="list-style-type: none"> <li>1x Reset Button</li> </ul>
Instant Reboot	<ul style="list-style-type: none"> <li>Support 0.2sec Instant Reboot Technology</li> </ul>
Watchdog Timer	<ul style="list-style-type: none"> <li>Software Programmable Supports 256 Levels System Reset</li> </ul>
<b>Power</b>	
Power Button	<ul style="list-style-type: none"> <li>1x ATX Power On/Off Button</li> </ul>
Power Mode Switch	<ul style="list-style-type: none"> <li>1x AT/ATX Mode Switch</li> </ul>
Power Input	<ul style="list-style-type: none"> <li>9-48VDC, 3-pin Terminal Block</li> </ul>
Remote Power On/Off	<ul style="list-style-type: none"> <li>1x Remote Power On/Off, 2-pin Terminal Block</li> </ul>
Remote Power LED	<ul style="list-style-type: none"> <li>1x Remote Power LED, 2-pin Terminal Block</li> </ul>
<b>Physical</b>	
Dimension (W x D x H)	<ul style="list-style-type: none"> <li>203 x 142 x 66.8 mm</li> </ul>
Weight Information	<ul style="list-style-type: none"> <li>1.8 KG</li> </ul>

Mechanical Construction	<ul style="list-style-type: none"> <li>Extruded Aluminum with Heavy Duty Metal</li> </ul>
Mounting	<ul style="list-style-type: none"> <li>Wall / Side / DIN-RAIL / VESA Mount</li> </ul>
Physical Design	<ul style="list-style-type: none"> <li>Fanless Design</li> <li>Cableless Design</li> <li>Jumper-less Design</li> <li>Unibody Design</li> </ul>
<b>Reliability &amp; Protection</b>	
Reverse Power Input Protection	<ul style="list-style-type: none"> <li>Yes</li> </ul>
Over Voltage Protection	<ul style="list-style-type: none"> <li>Protection Range: 51-58V</li> <li>Protection Type: shut down operating voltage, re-power on at the present level to recover</li> </ul>
Over Current Protection	<ul style="list-style-type: none"> <li>15A</li> </ul>
CMOS Battery Backup	<ul style="list-style-type: none"> <li>SuperCap Integrated for CMOS Battery Maintenance-free Operation</li> </ul>
MTBF	<ul style="list-style-type: none"> <li>486,235 Hours - Database: Telcordia SR-332 Issue3, Method 1, Case 3</li> </ul>
<b>Operating System</b>	
Windows	<ul style="list-style-type: none"> <li>Windows®11, Windows®10</li> </ul>
Linux	<ul style="list-style-type: none"> <li>Ubuntu 22.04</li> </ul>
<b>Environment</b>	
Operating Temperature	<ul style="list-style-type: none"> <li>-40°C to 70°C</li> <li>* PassMark BurnInTest: 100% CPU, 2D/3D Graphics (without thermal throttling)</li> <li>* With extended temperature peripherals; Ambient with air flow</li> <li>* According to IEC60068-2-1, IEC60068-2-2, IEC60068-2-14</li> </ul>
Storage Temperature	<ul style="list-style-type: none"> <li>-40°C to 70°C</li> </ul>
Relative Humidity	<ul style="list-style-type: none"> <li>95%RH @ 70°C (non-Condensing)</li> </ul>
Shock	<ul style="list-style-type: none"> <li>MIL-STD-810H</li> </ul>
Vibration	<ul style="list-style-type: none"> <li>MIL-STD-810H</li> </ul>
EMC	<ul style="list-style-type: none"> <li>CE, UKCA, FCC, ICES-003 Class A</li> <li>EN IEC 61000-6-4 / EN IEC 61000-6-2 (24VDC Input Only)</li> <li>EN 50155 (EN 50121-3-2 Only)</li> <li>E-mark (Pending)</li> </ul>
EMI	<ul style="list-style-type: none"> <li>CISPR 32 Conducted &amp; Radiated: Class A</li> <li>EN/BS EN 50121-3-2 Conducted &amp; Radiated: Class A</li> <li>EN/BS EN IEC 61000-3-2 Harmonic current emissions: Class A</li> <li>EN/BS EN 61000-3-3 Voltage fluctuations &amp; flicker</li> <li>FCC 47 CFR Part 15B, ICES-003 Conducted &amp; Radiated: Class A</li> </ul>
EMS	<ul style="list-style-type: none"> <li>EN/IEC 61000-4-2 ESD: Contact: 6 kV; Air: 8 kV</li> <li>EN/IEC 61000-4-3 RS: 80 MHz to 1000 MHz: 20 V/m</li> <li>EN/IEC 61000-4-4 EFT: AC Power: 2 kV; DC Power: 2 kV; Signal: 2 kV</li> <li>EN/IEC 61000-4-5 Surges: AC Power: 2 kV; Signal: 1 kV</li> <li>EN/IEC 61000-4-6 CS: 10V</li> <li>(**Compliant with the standard when utilizing shielded cable.)</li> <li>EN/IEC 61000-4-8 PFMF: 50 Hz, 30A/m</li> <li>EN/IEC 61000-4-11 Voltage Dips &amp; Voltage Interruptions: 1 cycles at 60 Hz</li> </ul>
Safety	<ul style="list-style-type: none"> <li>UL, cUL, CB, IEC, EN 62368-1</li> </ul>

*\* Product Specifications and features are for reference only and are subject to change without prior notice. For more information, please refer to the latest product datasheet from Cincoze's website.*

# 1.3 External Layout

## 1.3.1 Front

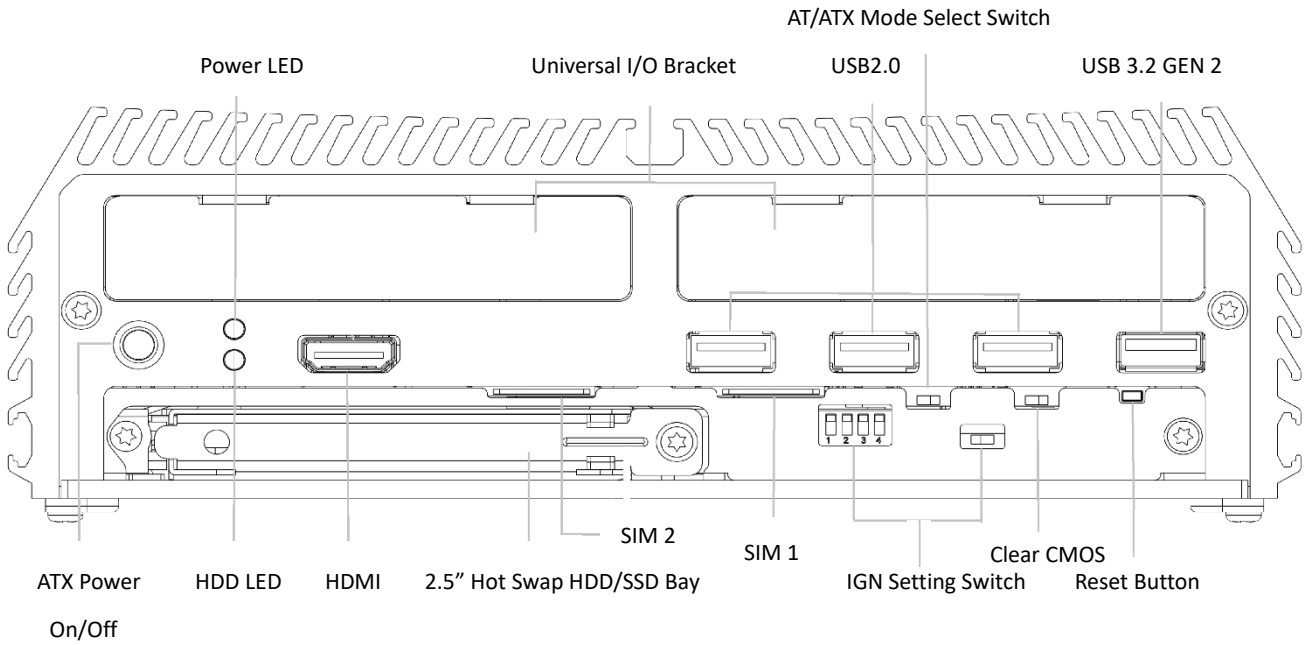

## 1.3.2 Rear

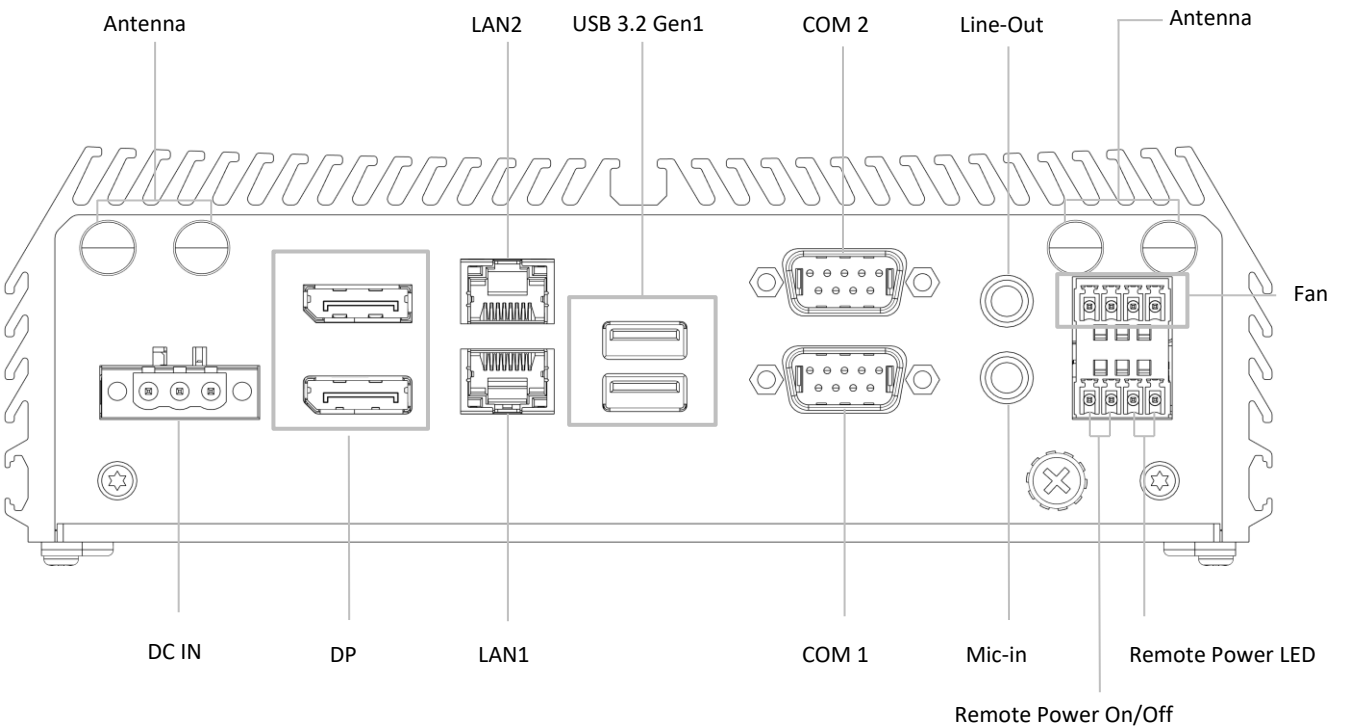



# 1.4 Dimensions

Unit: mm

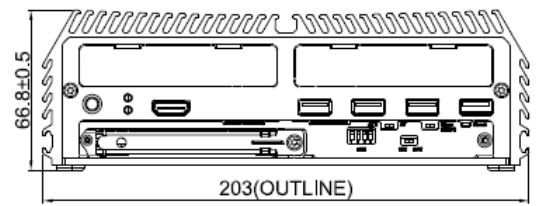
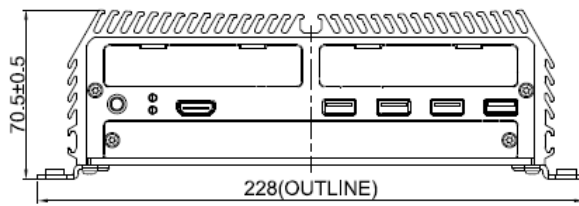
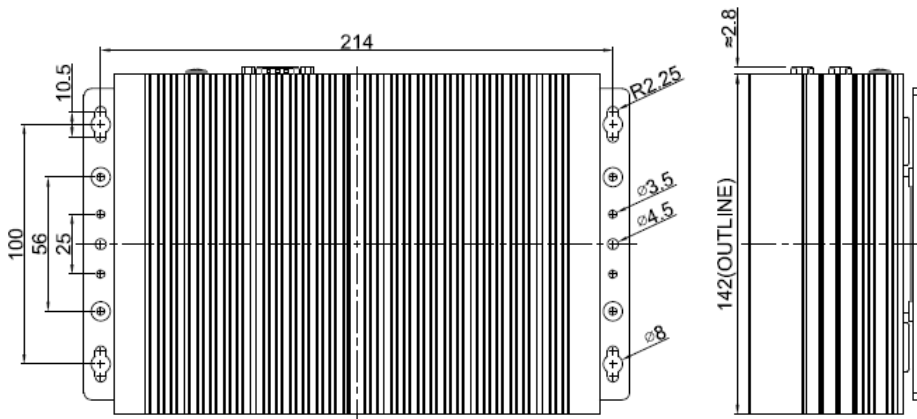



# **Chapter 2**

## **Introduction to Switches & Connectors**

## 2.1 Location of System Switches and Connectors

### 2.1.1 Top View

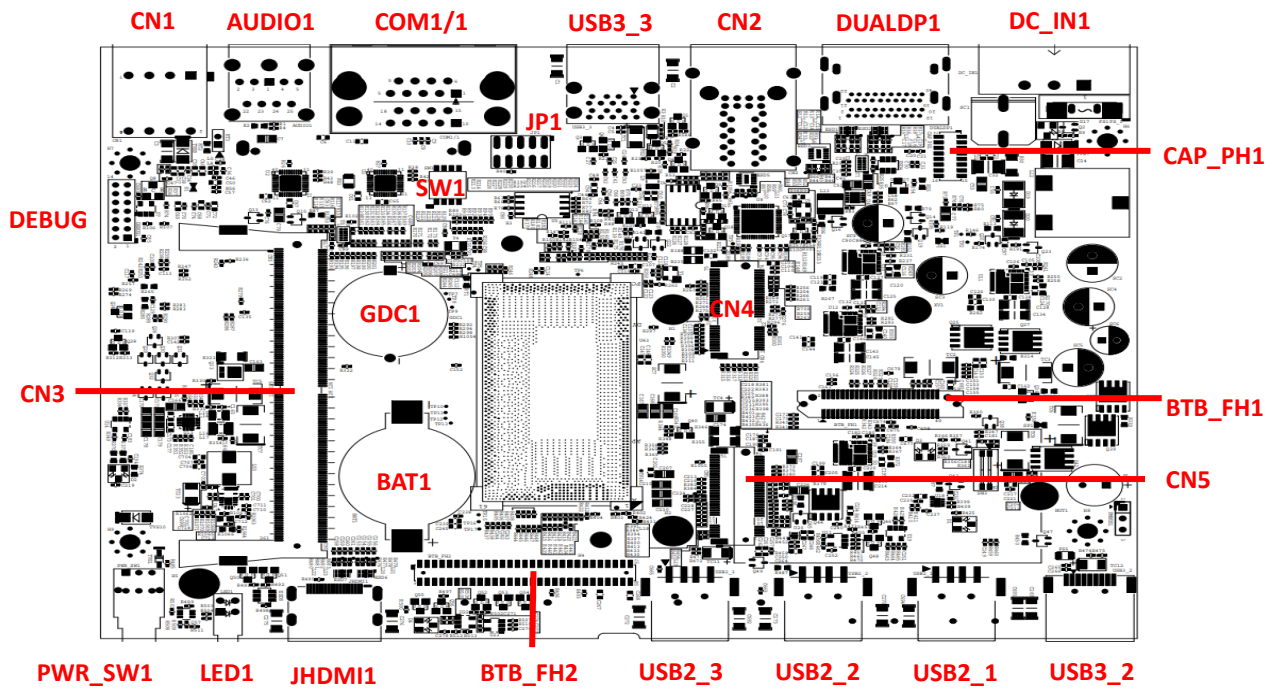

### 2.1.2 Bottom View

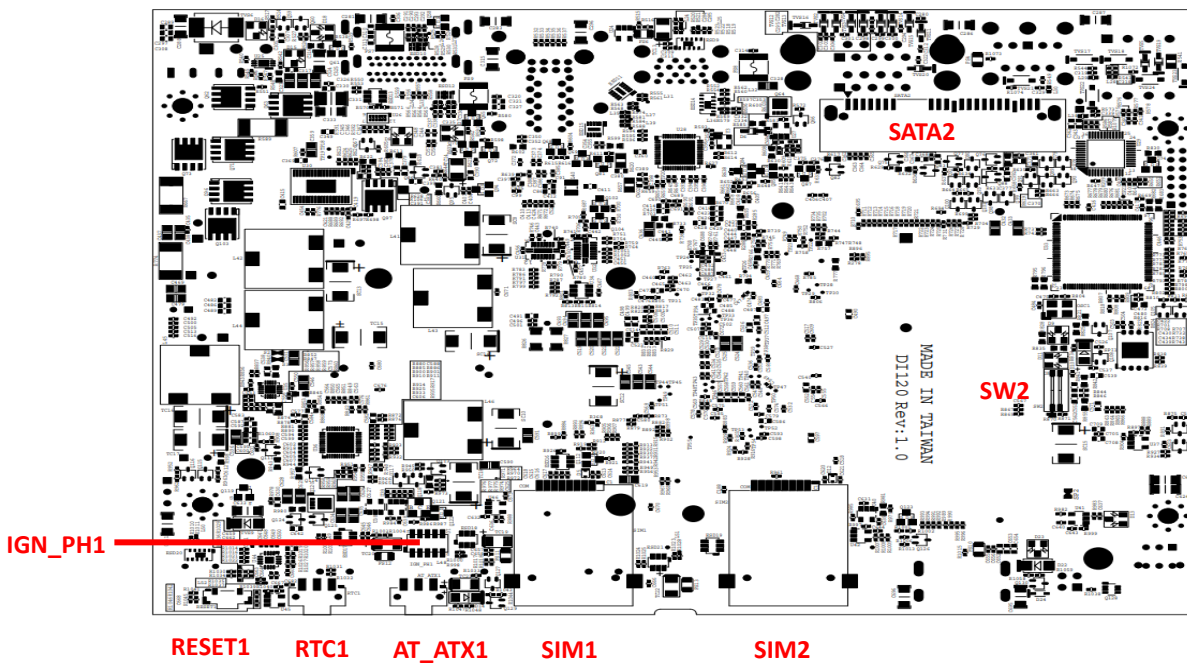

## 2.2 Switches and Connectors Definition

Location	Definition
AT_ATX1	AT / ATX Power Mode Switch
AUDIO1	Headphone and mic connector
BAT1	RTC Battery Holder
BTB_FH1	CMI slot, support PCIE 1X4 or 4x1 LAN/POE
BTB_FH2	CMI 30 pins slot, support 8 in 8 out DIO or COM3/4 CMI 26 pins slot, support DDI (CMI for VGA, HDMI, DP)
CAP_PH1	Cap Board board-to-board Connector
CN1	CN1: CPU Smart Fan Connector and Remote Power on/off Switch Connector and Remote Power LED Connector
CN2	Dual LAN RJ-45 Connector (Support 2.5G)
CN3	DDR5 SO-DIMM Connector
CN4	M.2 Key E Socket (Support PCIE/USB2/CNVi)
CN5	M.2 Key B Socket (Support PCIE/SATA/USB3/USB2/Dual SIM Card)
COM1/1	COM1 and COM2 Connector (Support RS232/RS422/RS485)
DC_IN1	3 Pins DC 9-48V power input with power ignition connector
DEBUG1	Debug port Header (80 Port)
DUALDP1	Dual Display port connector (Support DP++)
GDC1	Super Cap for CMOS Backup
IGN_PH1	CFM-IGN module connector
JHDMI1	HDMI connector
JP1	SPI Programmer connector
LED1	LED for Power and LED for SATA/ KEY B SSD
PWR_SW1	System Power button
RESET1	System Reset button
RTC1	Clear CMOS Setting switch
SATA2	22 Pin SATA connector
SIM1, SIM2	SIM Card socket A and B
SW1	COM1 and COM2 Power Select Switch
SW2	Super CAP Control Switch
USB2_1	USB2.0 1-Port TYPE A connector
USB2_2	USB2.0 1-Port TYPE A connector
USB2_3	USB2.0 1-Port TYPE A connector
USB3_2	USB3.2 GEN2 x1 1-Port TYPE A connector
USB3_3	USB3.2 GEN1 x1 2-Port TYPE A connector

## 2.3 Definition of Switches

### AT\_ATX1: AT / ATX Power Mode Switch

Switch	Definition
Left	ATX Power Mode (Default)
Right	AT Power Mode



### CN2: Dual LAN RJ-45 connector (Support 2.5G)

#### LAN LED Status Definition

Link LED Status	Definition
Steady Green	2.5 Gbps Network Link
Steady Orange	1 Gbps Network Link
Off	100 Mbps/ 10 Mbps Network Link
Act LED Status	Definition
Blinking Yellow	Data Activity
Steady Yellow	No Activity

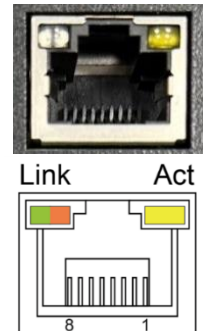

### LED1: LED for Power and LED for SATA/ KEY B SSD

Switch	LED Color	Definition
POWER LED	Green	POWER ON
	Colorless	POWER OFF
	Blinking Green	Stand by
HDD LED	Yellow	HDD Read/Write
	Colorless	No Operation



### PWR\_SW1: System Power Button

Switch	Definition
Push	Power up the System



### RESET1: System Reset Button

Switch	Definition
Push	Reset System



### RTC1: Clear CMOS Setting Switch

Switch	Definition
Left	Normal (Default)
Right	Clear CMOS



### SW1: COM1 and COM2 Power Select Switch

Location	Function	DIP1	DIP2
SW1	COM1	RI	ON (Default)
		5V	ON
		12V	OFF
Location	Function	DIP3	DIP4
SW1	COM2	RI	ON (Default)
		5V	ON
		12V	OFF

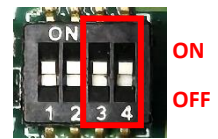
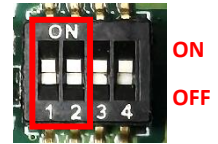

### SW2: Super CAP Control Switch

Location	Function	DIP1	DIP2
SW2	Super CAP Enabled	ON (Default)	ON (Default)
	Super CAP Disabled	OFF	



## 2.4 Definition of Connectors

### CN1: CPU Smart Fan Connector and Remote Power on/off Switch Connector and Remote Power LED Connector

Remote Power LED connector can connect an external LED indicator up to 10mA.

Connector Type: Terminal Block 2X4 8-pin, 3.5mm pitch

Pin	Definition	Pin	Definition
1	PWR_SW	2	GND
3	GND	4	+12V
5	Power LED	6	FAN_SENSE
7	GND	8	FAN_PWM



**WARNING**  
**(AVERTIR)**

**For Remote Power on/off Switch Connector (pin 1 & pin 3) : Do not apply any power to this connector! This port is used to connect a SWITCH!**

**(Pour la télécommande de mise sous/hors tension (broche 1 et broche 3) : Ne fournissez aucune alimentation à ce connecteur ! Ce port est utilisé pour connecter un INTERRUPTEUR !)**

### CN4 : M.2 Key E Socket (Support PCIE/USB2/ CNVi interface)

Pin No.	PIN Name	Pin No.	Pin name
1	GND	2	+3.3V
3	USB2_D+	4	+3.3V
5	USB2_D-	6	N.C
7	GN	8	PCM_CLK
9	WGR_D1N	10	PCM_SYNC/LPC_RSTN
11	WGR_D1P	12	PCM_IN
13	GND	14	PCM_OUT
15	WGR_D0N	16	N.C
17	WGR_D0P	18	GND
19	GN	20	UART_WAKE#
21	WGR_CLKN	22	UART_RX/BRI_RSP
23	WGR_CLKP	24	Key
25	Key	26	Key
27	Key	28	Key
29	Key	30	Key
31	Key	32	UART/RGI_DT
33	GND	34	UART_CTS/RGI_RSP
35	PETp0	36	UART_RTS/BRI_DT
37	PETn0	38	CLINK_REST
39	GND	40	CLINK_DATA
41	PERp0	42	CLINK_CLK
43	PERn0	44	COEX3
45	GND	46	COEX2
47	REFCLKP0	48	COEX1
49	REFCLKN0	50	SUSCLK
51	GND	52	PERST0#
53	CLKREQ0#	54	W_DISABLE2#
55	PEWAKE0#	56	W_DISABLE1#
57	GND	58	I2C_DATA
59	WTD1N/PETP1	60	I2C_CLK
61	WTD1N/PETN1	62	ALERT#
63	GND	64	REF_CLK
65	WTD0N/PERP1	66	UIM_SWP/PERST1#
67	WTD0P/PERN1	68	UIM_PWR_SNK/CLKREQ1#
69	GND	70	UIM_PWR_SRC/PEWAKE1#
71	WTCLKN/REFCLKP1	72	+3.3V
73	WTCLKP/REFCLKN1	74	+3.3V
75	GND		

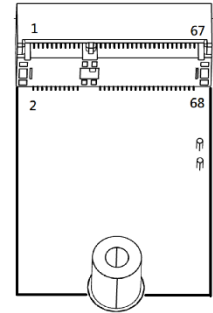

### CN5 : M.2 Key B Socket (Support PCIE/SATA/USB3/USB2/Dual SIM Card)

Pin No.	PIN Name	Pin No.	Pin name
1	CFG3	2	+3.3V
3	GN	4	+3.3V
5	GN	6	FULL_CARD_POWER_OFF_N
7	USB2 D+	8	W_DISABLE1_N
9	USB2 D-	10	LED1_N
11	GND	12	Key
13	Key	14	Key
15	Key	16	Key
17	Key	18	Key
19	Key	20	GPIO_5
21	CFG0	22	GPIO_6
23	GPIO_11	24	GPIO_7
25	DPR	26	GPIO_10
27	GN	28	GPIO_8
29	PERn1 /USB3_RX-	30	USIM_RESET
31	PERp1 /USB3_RX+	32	USIM_CLK
33	GN	34	USIM_DATA
35	PETn1 /USB3_TX-	36	USIM_PWR
37	PETp1 /USB3_TX+	38	DEVSLP
39	GN	40	USIM_DET2
41	PERn0 /SATA_B+	42	USIM_DATA2
43	PERp0 /SATA_B-	44	USIM_CLK2
45	GN	46	USIM_RESET2
47	PETn0 /SATA_A-	48	USIM_PWR2
49	PETp0 /SATA_A+	50	PERST#
51	GND	52	CLKREQ#
53	REFCLKN	54	PEWAKE#
55	REFCLKP	56	NC
57	GND	58	NC
59	ANTCTL0	60	COEX3
61	ANTCTL1	62	COEX2
63	ANTCTL2	64	COEX1
65	ANTCTL3	66	USIM_DET
67	RESET#	68	SUSCLK
69	CFG1	70	+3.3V
71	GND	72	+3.3V
73	GND	74	+3.3V
75	CFG2		

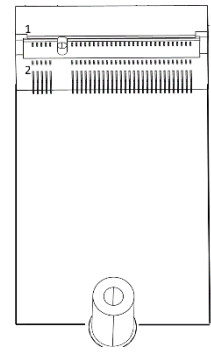



### COM1\_1: COM1 and COM2 Connector (Support RS232/RS422/RS485)

Connector Type: 9-pin D-Sub

Pin	RS232 Definition	RS422 / 485 Full Duplex Definition	RS485 Half Duplex Definition
1	DCD	TX-	DATA -
2	RXD	TX+	DATA +
3	TXD	RX+	
4	DTR	RX-	
5	GND		
6	DSR		
7	RTS		
8	CTS		
9	RI		



### DC\_IN1: 3 Pins DC 9-48V power input with power ignition connector

Connector Type: Terminal Block 1x3 3-pin, 5.0mm pitch

Pin	Definition
1	+9-48VIN
2	Ignition (IGN)
3	GND

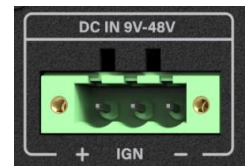

1 2 3



CAUTION  
(ATTENTION)

Please disconnect the power source before mounting the DC power cables or connecting the DC power connector to system.

(Veuillez débrancher la source d'alimentation avant de monter les câbles d'alimentation CC ou de connecter le connecteur d'alimentation CC au système.)

## 2.5 Optional Module Pin Definition & Settings

### 2.5.1 CMI-COM05-R10 Module

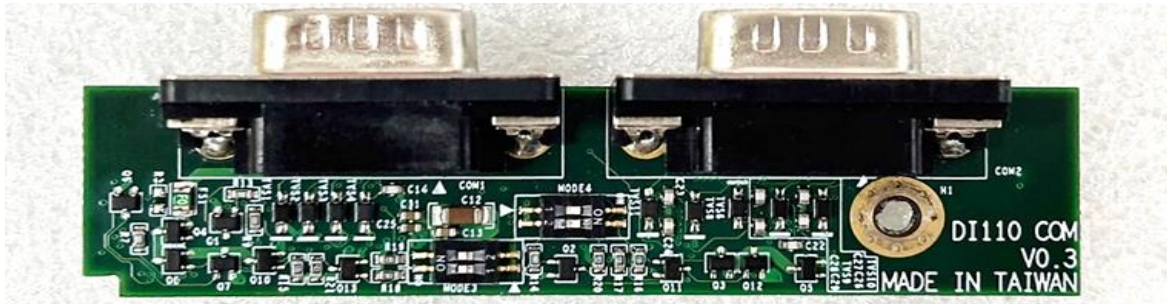

**COM1 and COM2 (on the module) : COM3 and COM4 Connector (Support RS232/RS422/RS485)**  
Connector Type: 9-pin D-Sub

Pin	RS232 Definition	RS422 / 485 Full Duplex Definition	RS485 Half Duplex Definition
1	DCD	TX-	DATA -
2	RXD	TX+	DATA +
3	TXD	RX+	
4	DTR	RX-	
5	GND		
6	DSR		
7	RTS		
8	CTS		
9	RI		



*\* After the proper installation of this module, the printed name COM1 and COM2 on the module correspond to serial ports 3 and 4 in the system BIOS. Therefore, we designate the module's COM ports as COM3 and COM4 as the system motherboard already possesses COM1 and COM2.*

**MODE3 (on the module) : COM3 Power Select Switch**

Location	Function	DIP1	DIP2	
MODE3	COM3	RI	ON (Default)	ON (Default)
		5V	ON	OFF
		12V	OFF	OFF



**MODE4 (on the module) : COM4 Power Select Switch**

Location	Function	DIP1	DIP2	
MODE4	COM4	RI	ON (Default)	ON (Default)
		5V	ON	OFF
		12V	OFF	OFF



## 2.5.2 CMI-DIO05-R10 Module

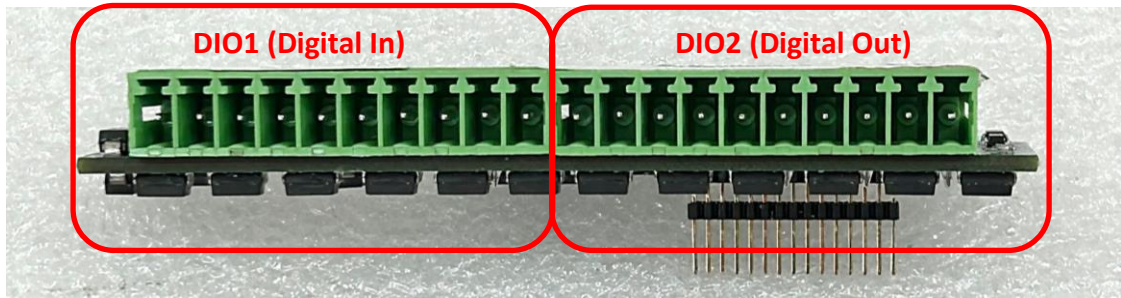

### DIO1 (on the module): Digital IN Connector

Connector Type: Terminal Block 1X10 10-pin, 3.5mm pitch

Pin	Definition	Pin	Definition
1	XCOM+ (DC INPUT)	6	DI5
2	DI1	7	DI6
3	DI2	8	DI7
4	DI3	9	DI8
5	DI4	10	XCOM- (GND)



### DIO2 (on the module) : Digital OUT Connector

Connector Type: Terminal Block 1X10 10-pin, 3.5mm pitch

Pin	Definition	Pin	Definition
1	XCOM+ (DC INPUT)	6	DO5
2	DO1	7	DO6
3	DO2	8	DO7
4	DO3	9	DO8
5	DO4	10	XCOM- (GND)



### 2.5.3 CFM-IGN102 Module

#### SW1 (on the module) : IGN Module Timing Setting Switch

Set shutdown delay timer when ACC is turned off

Pin 1	Pin 2	Pin 3	Pin 4	Definition
ON (IGN Enabled)	ON	ON	ON	0 second
	ON	ON	OFF	1 minute
	ON	OFF	ON	5 minutes
	ON	OFF	OFF	10 minutes
/	OFF	ON	ON	30 minutes
	OFF	ON	OFF	1 hour
	OFF	OFF	ON	2 hours
	OFF	OFF	OFF	Reserved (0 second)



OFF  
ON

Default setting of Pin1 to Pin4 is OFF/OFF/OFF/OFF.

#### 24V\_12V\_1 (on the module) : IGN Module Voltage Mode Setting Switch

##### 12V / 24V Car Battery Switch

Switch	Definition
Left	12V Car Battery Input
Right	24V Car Battery Input (Default)



12V 24V

### 2.5.4 CMI-LAN01-R12 Module

#### LAN LED Status Definition

Link LED Status	Definition
Steady Green	1 Gbps Network Link
Steady Orange	100 Mbps Network Link
Off	10 Mbps Network Link
Act LED Status	Definition
Blinking Yellow	Data Activity
Steady Yellow	No Activity

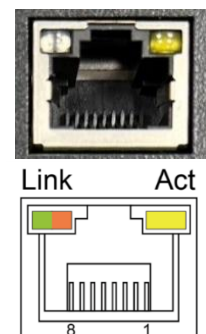

Link Act

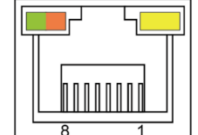

## 2.5.5 CMI-M12LAN01-R12 Module

### CMI-M12LAN01 Module Pin Definitions

Connector Type: M12 A-coded 8pin connector

Pin	Definition	Pin	Definition
1	2_LAN1_0+	2	2_LAN1_0-
3	2_LAN1_1+	4	2_LAN1_2+
5	2_LAN1_2-	6	2_LAN1_1-
7	2_LAN1_3+	8	2_LAN1_3-

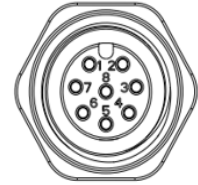

## 2.5.6 CMI-XM12LAN01-R10 Module

### CMI-XM12LAN01 Module Pin Definitions

Connector Type: M12 X-coded 8pin connector

Pin	Definition	Pin	Definition
1	D1+	2	D1-
3	D2+	4	D2-
5	D4+	6	D4-
7	D3-	8	D3+

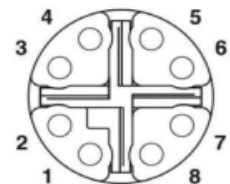

## 2.5.7 CMI-10GLAN04-R10 Module

### LAN LED Status Definition

Link LED Status	Definition
Steady Green	10 Gbps Network Link
Steady Orange	1 Gbps Network Link
Off	100 Mbps Network Link
Act LED Status	Definition
Blinking Green	Data Activity
Steady Green	No Activity

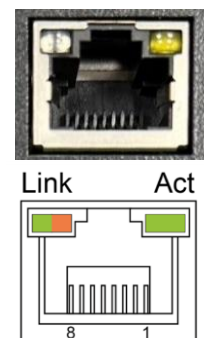

\* Before installing CMI-10GLAN04-R10 module, users need to enter BIOS to complete the following setting first. When entering BIOS, get to Chipset > PCH-IO Configuration page, and change the [BTB\_FH1 Mode Selection] setting from default mode [4x1] to mode [1x4].



# **Chapter 3**

## **System Setup**

## 3.1 Removing Top Cover



WARNING  
(AVERTIR)

In order to prevent electric shock or system damage, must turn off power and disconnect the unit from power source before removing the chassis cover.

(Afin d'éviter tout risque d'électrocution ou d'endommagement du système, vous devez couper l'alimentation et débrancher l'appareil de la source d'alimentation avant de retirer le couvercle du châssis.)

Step 1: Loosen the 6 screws on the bottom panel of the system.



Step 2. Remove the bottom panel and then the system body from the chassis.



Step 3. Place the system body aside gently.



## 3.2 Installing SO-DIMM Memory

Step 1. Locate the SO-DIMM sockets.

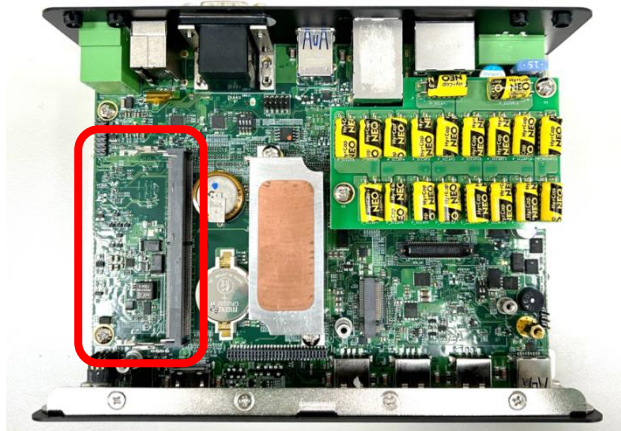

Step 2. Tilt the SO-DIMM module at a 45-degree angle and insert it to SO-DIMM socket until the gold-pated connector of module contacted firmly with the socket.



Step 3. Press the modules down until it's fixed firmly by the two locking latches on each side.

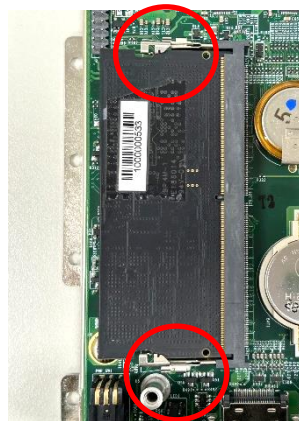



### 3.3 Installing M.2 Key B Module



NOTE  
(NOTE)

When a high-speed CMI module is installed, the maximum height of the M.2 Key B add-on module is listed as below:

CMI Modules	Max. Height of M.2 Key B Module
CMI-LAN01	3.2 mm
CMI-M12LAN01	3.2 mm
CMI-XM12LAN01	3.2 mm
CMI-10GLAN04	2.6 mm

#### 3.3.1 M.2 Key B type 3052

Step 1. Locate the M.2 Key B slot.

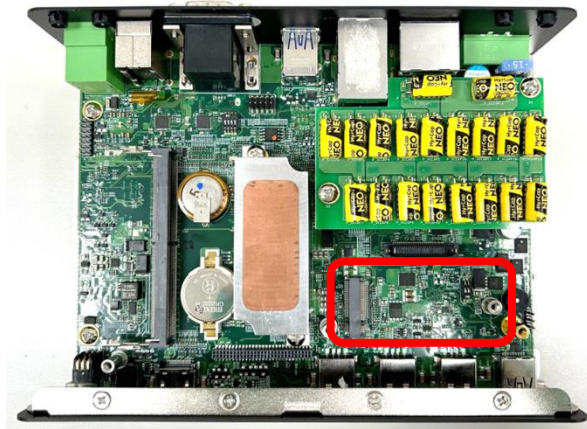

Step 2. Insert the M.2 Key B module at a 45-degree angle and insert it to the slot until the gold-pated connector of module contacted firmly with the slot.



Step 3. Press down the module and fasten the screw to secure the module.



### 3.3.2 M.2 Key B type 3042

Step 1. Locate the M.2 Key B slot.

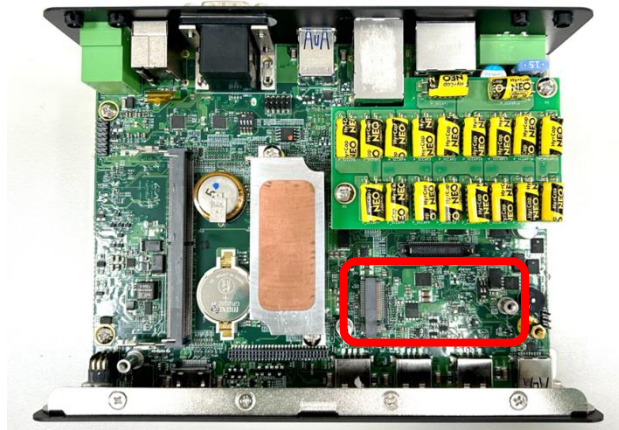

Step 2: Align the M.2 Key B Type 3052 to 3042 Adapter Bracket with the corresponding screw hole. Secure the bracket in place and fasten the screw.

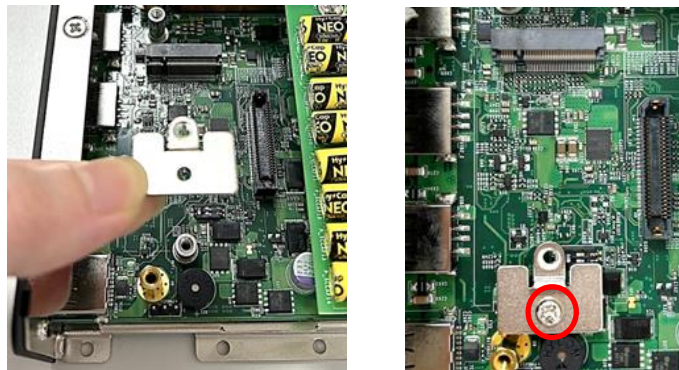

Step 3. Insert the M.2 Key B module at a 45-degree angle and insert it to the slot until the gold-pated connector of module contacted firmly with the slot.



Step 4. Press down the module and fasten the screw to secure the module.

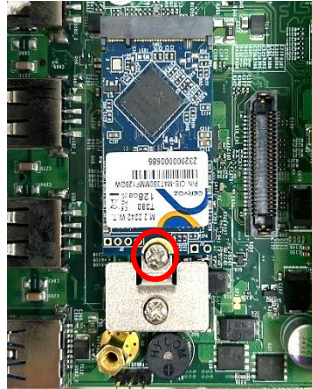

### 3.4 Installing M.2 Key E Module

If the pre-installed module requires connection to an antenna (i.e., the antenna is to be connected to the module installed in slot CN4), please refer to [Chapter 3.5](#) to finish the antenna installation first.



NOTE  
(NOTE)

The maximum height of the M.2 Key E add-on module is limited to 6.7mm.

Step 1. Loosen and remove the two screws, then proceed to carefully detach the CAP board.

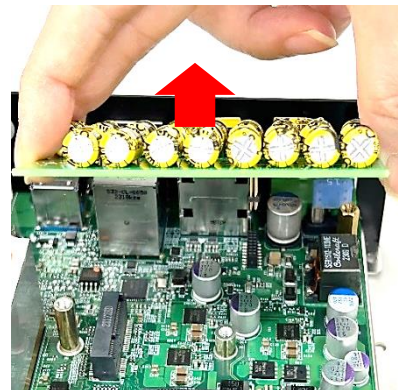

Step 2. Locate the M.2 Key E slot on the system board.



Step 3. Tilt the M.2 Key E card at a 45-degree angle and insert it to the socket until the golden finger connector of the card seated firmly.

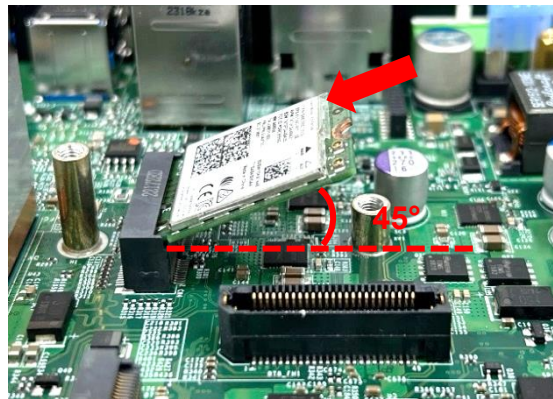

Step 3. Press the card down and secure it with one screw.

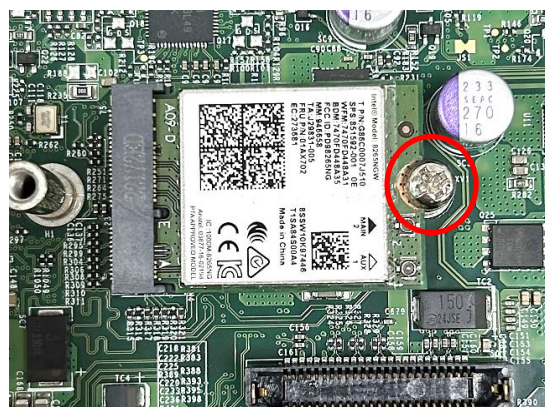

Step 4. Insert the CAP board with precision, ensuring that each pin is aligned with its corresponding hole on the socket. Secure the board in place by tightening the two screws.

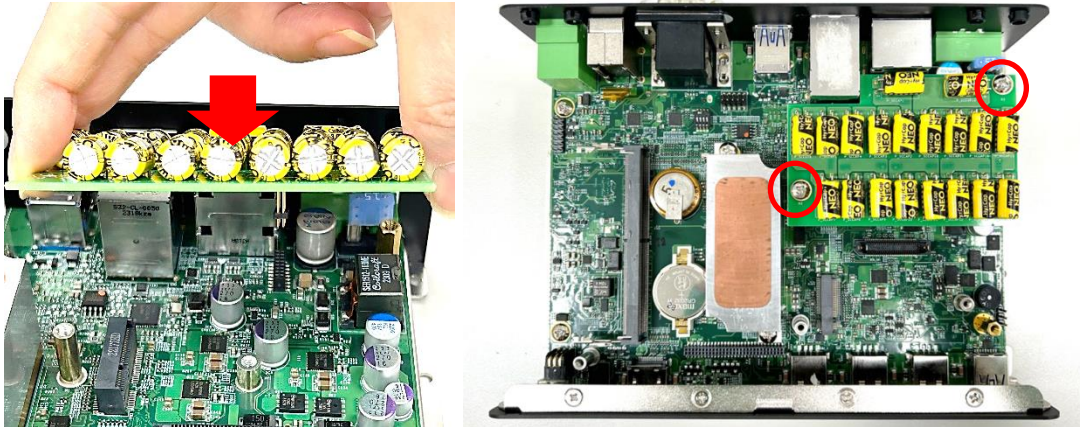

### 3.5 Installing Antenna(s)

Please install a Wireless Module before antenna installation. If the module is installed in slot CN4, please complete the installation steps from 1 to 3 in [Chapter 3.4](#) first, and then proceed to Step 4 **only after** completing the antenna installation in this chapter.

Step 1. Remove the antenna hole cover(s) on the rear panel of the system.



Step 2. Have the antenna jack penetrate through the hole.



Step 3. Put on the washer and fasten the nut with the antenna jack.



Step 4. Assemble the antenna and antenna jack together.



Step 5. Attach the RF connector at another end of cable onto the module.

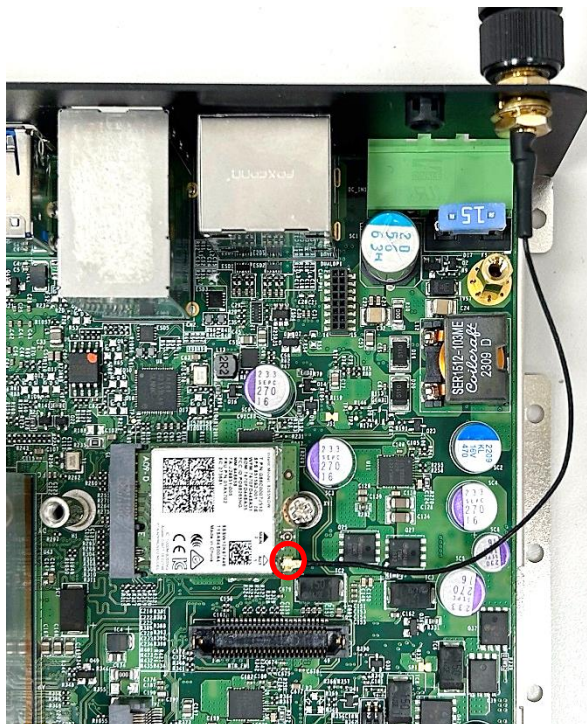

### 3.6 Installing CPU Heatsink Thermal Pad

Step 1. Peel off the protective film from one side of the Thermal Pad.

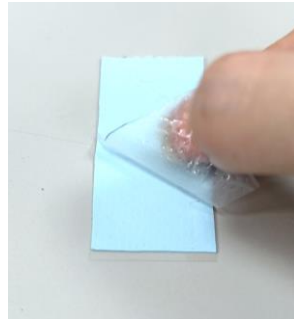

Step 2. Place the thermal pad onto the CPU heatsink, ensuring the peeled side faces downward.



Step 3. Remove the protective film from the other side of the Thermal Pad.



**CAUTION  
(ATTENTION)**

**Before assembling the system's chassis cover, please make sure the protective films on the Thermal Pad have been removed!**

**(Avant d'assembler le couvercle du châssis du système, assurez-vous que le film protecteur sur le coussin thermique a été retiré !)**



### 3.7 Installing Top Cover

Step 1. Put the system body back into the chassis and then put on the bottom panel.



Step 2. Fasten the 6 screws back to the bottom panel of the system.



### 3.8 Installing SATA Hard Drive

Step 1. Loosen the 2 screws on the front panel without removing them to take off the cover plate.



Step 2. Loosen the screw on the HDD bracket.



Step 3. Pull out the HDD bracket.



Step 4. Make the bottom side of the HDD face up, place the HDD bracket on it. Ensure the direction of bracket is correct and use 4 provided screws to assemble HDD and HDD bracket together.



Step 5. Align the HDD bracket with the entrance of HDD bay. And insert the HDD bracket until the connector of HDD contact the SATA connector firmly.



Step 6. Fasten the screw on the HDD bracket.



Step 7. Fasten the 2 screws on the front panel.



### 3.9 Installing SIM Card

Please refer to [Chapter 3.3](#) to install a 5G/4G module at connect CN5 before the SIM card installation for the SIM application.

Step 1. Loosen the 2 screws on the front panel without removing them to take off the cover plate.



Step 2. Locate the SIM card slot(s).



Step 3. Insert the SIM card(s) into the SIM slot(s) with the gold contacts facing up. Please pay attention to the insert orientation as illustrated. (When SIM cards are inserted into both sockets, the network connection will prioritize SIM1.)

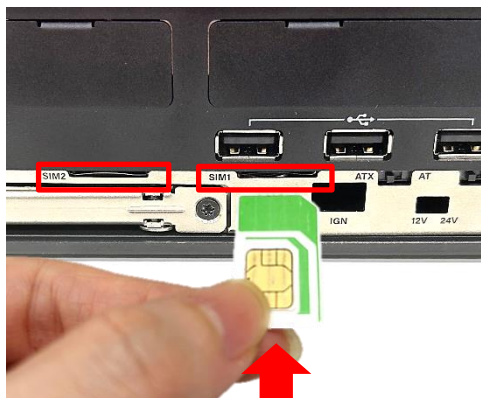

Step 4. Fasten the 2 screws on the front panel.



### 3.10 Installing Wall Mount

The DI-1200 series offers a wall mount kit included with the system (two wall mount brackets and one screw pack with size of M3x5L), allowing customers to install it on the wall in a convenient and economical way.

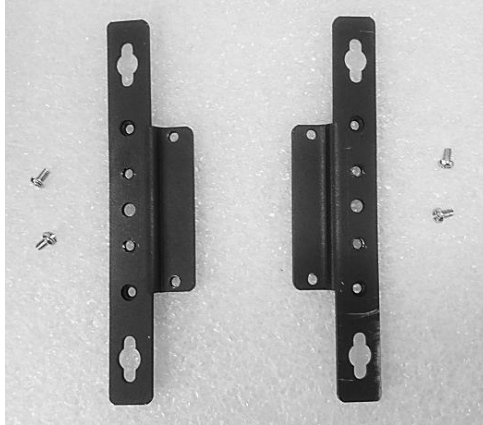

Step 1. Locate the four screw holes on the bottom panel of the system. Attach the brackets by aligning them with the four screw holes, and use the provided four screws (M3x5L) to secure the brackets on both sides of the system



Step 2. The indicated two mounting holes at left and right sides are designed to fix the system on the wall.



### 3.11 Installing VESA Mount

The following picture indicates VESA mounting holes on the DI-1200 series, which is compliant with VESA mounting standard. The blue holes correspond to the 75x75mm VESA mounting standard, and the green holes correspond to the 100x100mm VESA mounting standard.

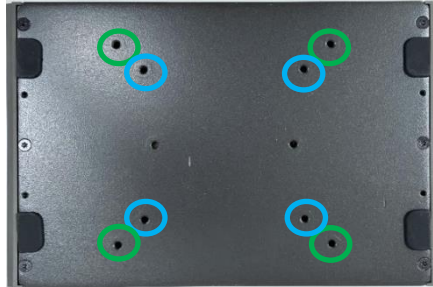

Step 1. Align the stand with the screw holes on the system, then secure it in place by tightening the corresponding number of screws as shown below. (Please note the VESA mounting holes deep 3 mm at the back of the terminal are provided with 4 x M4-type blind fasteners to fix the VESA mounting plate. A different screw length (L) should be selected.)

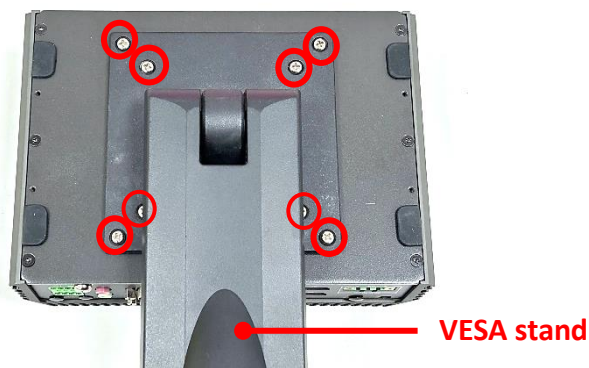

Step 2. Then, the VESA mount installation is complete.



### 3.12 Installing Side Mount

The DI-1200 series offers an optional accessory for side mounting, Side Mount Kit (Model No. SIDE01) as shown below. If you have acquired this accessory, please refer to the installation instructions hereafter.



Step 1. The mounting holes are at the bottom of system. Fasten the 4 screws to fix the side mount bracket with system together.

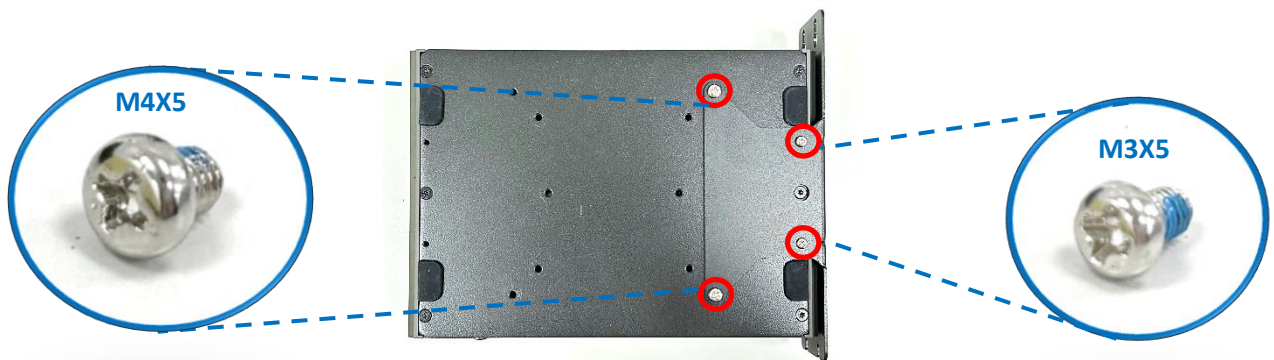

Step 2: It is feasible to secure the system to the wall by fastening the screws through the bracket mounting holes afterward.



### 3.13 Installing DIN-Rail Mount

The DI-1200 series offers an optional accessory for DIN-Rail mounting, DIN-RAIL Mount Kit (Model No. DINRAIL-R10) as shown below. If you have acquired this accessory, please refer to the installation instructions hereafter.



Step 1. Locate the two mounting holes for DIN-rail mounting on the bottom of system, and then fasten the 2 screws (with each screw size of P4x5L) to fix the DIN-Rail mounting bracket with the system together.

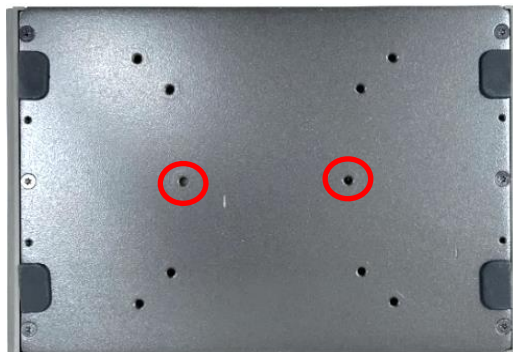

Step 2. Then user can clip the system into DIN rail through the DIN-RAIL Mount Kit.





## 3.14 Installing External FAN

The DI-1200 series offers an optional accessory of the External FAN (Model No. FAN-EX103) as shown in step 1. If you have acquired this accessory, please refer to the installation instructions hereafter.



NOTE

Please note that the external fan must be correctly installed and used when using the CFM-PoE optional module. (Veuillez noter que le ventilateur externe doit être correctement installé et utilisé lors de l'utilisation du module optionnel CFM-PoE.)

Step 1: Locate the two screws on the mounting frame.



Step 2: Loosen two screws without removing them.

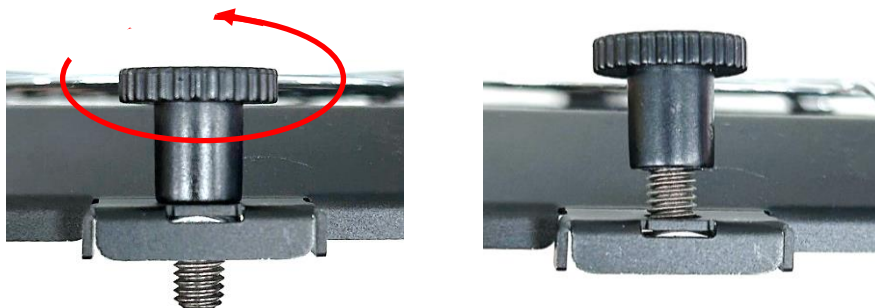

Step 3: Align the two screws and slide the fan into the middle groove of the chassis until it reaches the center position (the both screws will be in the groove at the same time).

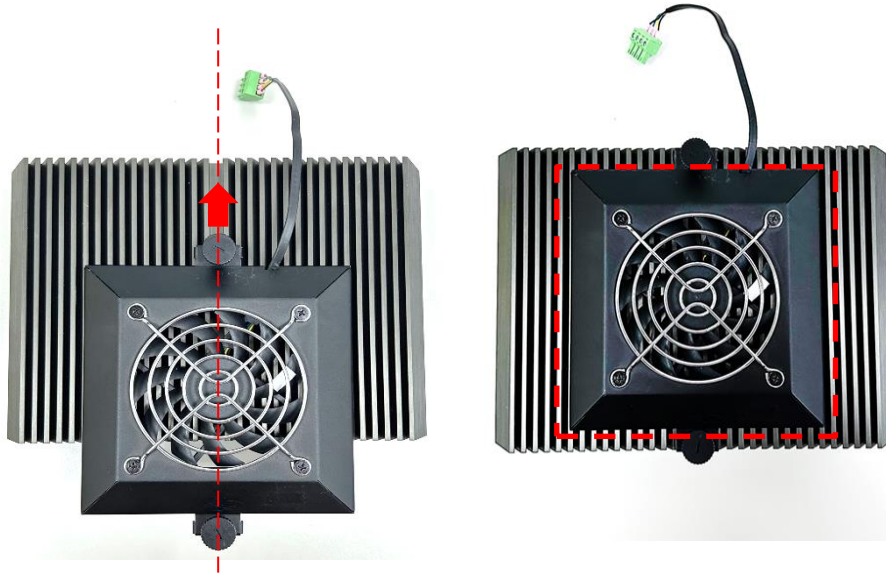

Step 4. Tighten the two screws.

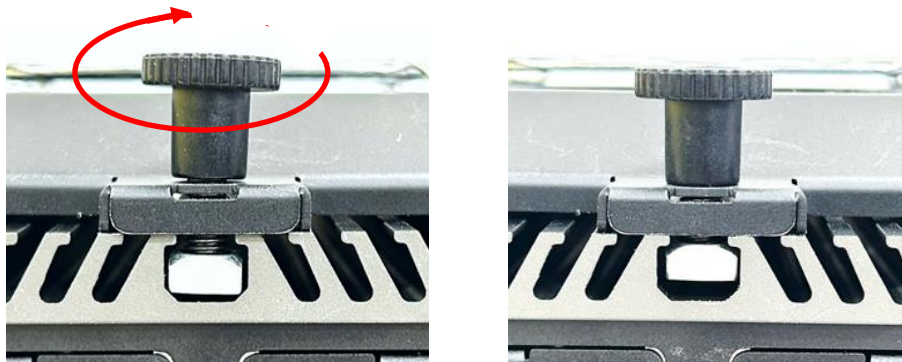

Step 5. Connect the FAN cable to external fan power connector firmly on the rear panel of the system.



## 3.15 Installing CMI Modules

### 3.15.1 CMI-LAN01-R12/UB1512-R11

Step 1. Locate the BTB\_FH1 connector of the CMI module on the top side of system.

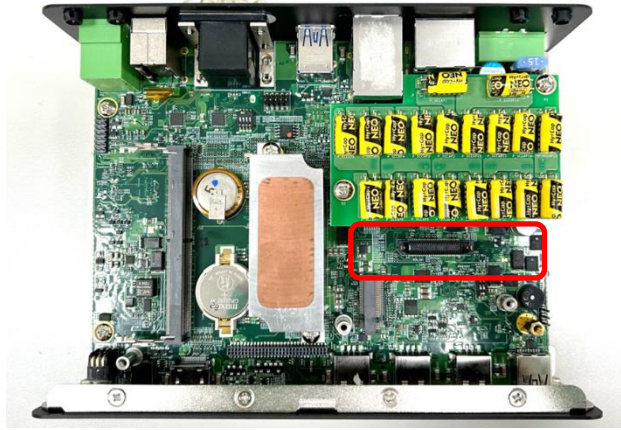

Step 2. Loosen the 2 screws and remove the front bezel.

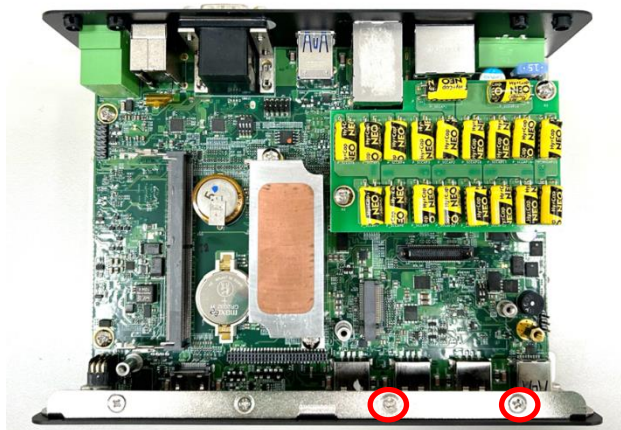

Step 3. Insert the CMI module vertically until it's connected firmly and fasten 2 screws to fix it.

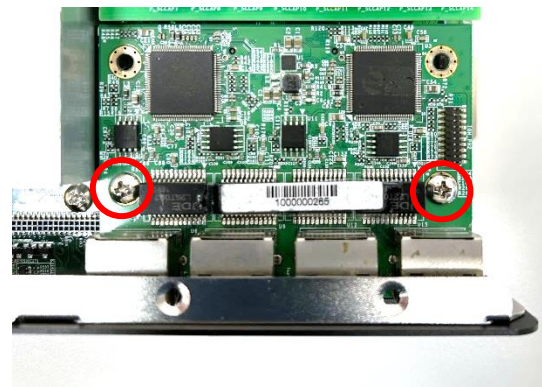

Step 4. Attach the I/O bracket on to the system, and fasten the two screws to fix it.

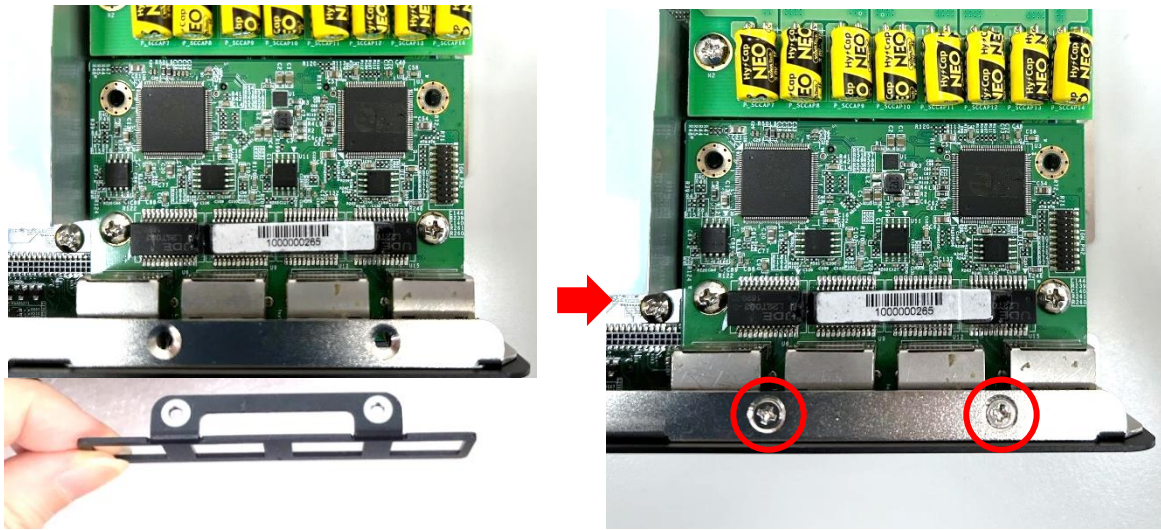

### 3.15.2 CMI-M12LAN01-R12/UB1510-R11

Step 1. Locate the BTB\_FH1 connector of the CMI module on the top side of system.

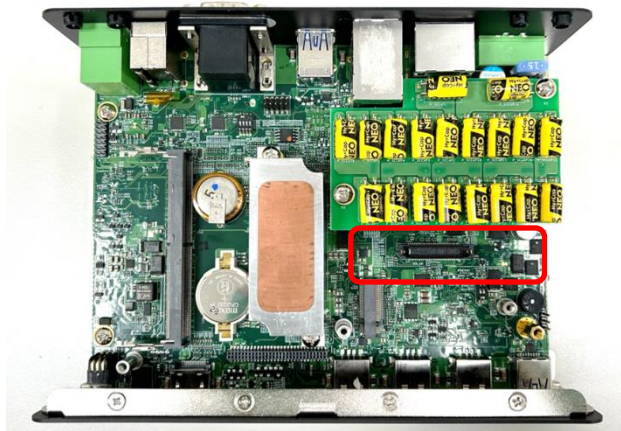

Step 2. Loosen the 2 screws and remove the front bezel.

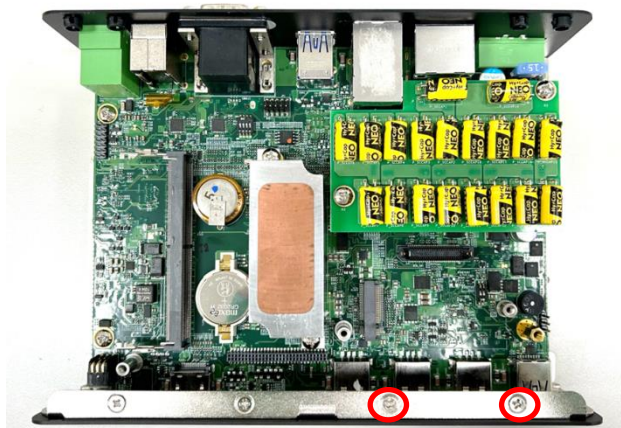

Step 3. Remove the four hex rings from the CMI-M12LAN module.

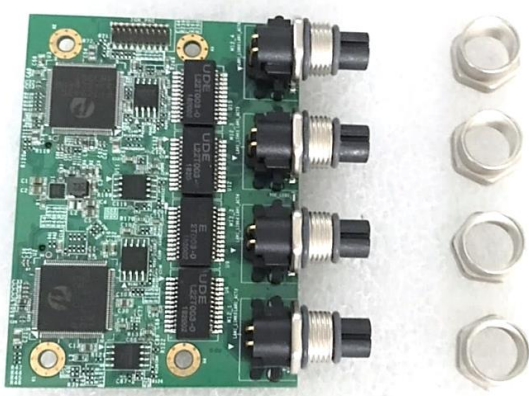

Step 4. Insert the CMI module vertically until it's connected firmly and fasten 2 screws to fix it.



Step 5. Attach the I/O bracket on to the system, and fasten the two screws to fix it.

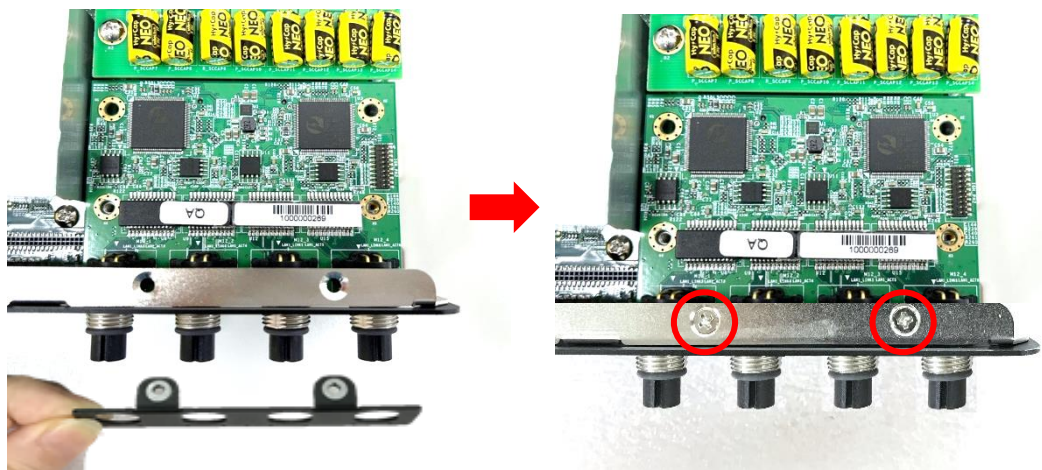

Step 6. Fasten the four hex rings back to fix the cover plate.

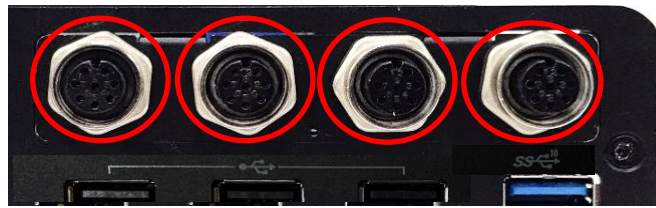

### 3.15.3 CMI-XM12LAN01-R10/UB1510-R11

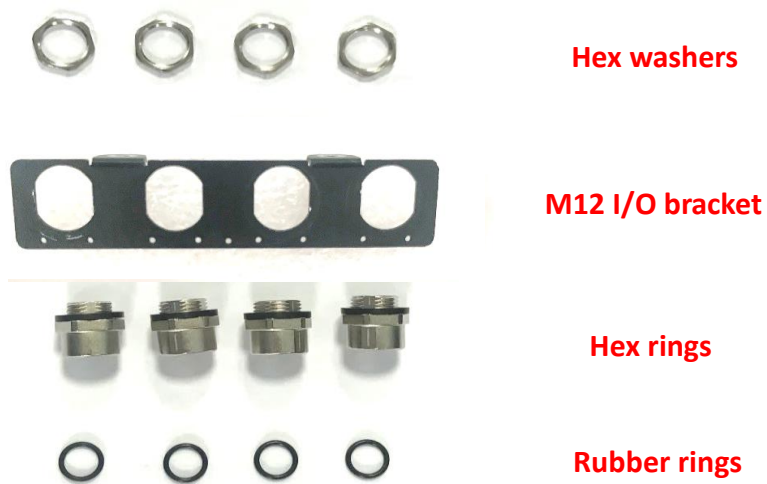

Step 1. Assemble the hex rings, M12 I/O bracket and hex washers together as indicated below:  
Penetrate hex rings through the M12 I/O bracket holes, and fix them with hex washers.



Step 2. Locate the BTB\_FH1 connector of the CMI module on the top side of system.



Step 3. Loosen the 2 screws and remove the front bezel.

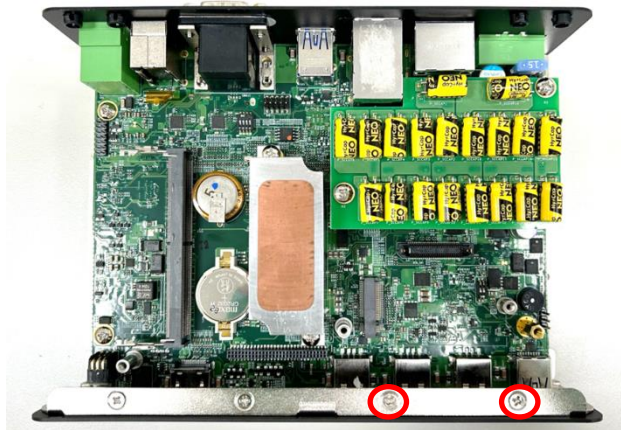

Step 4. Insert the CMI module vertically into the female connector on system's mainboard until it's connected firmly and fasten 2 screws to fix it.

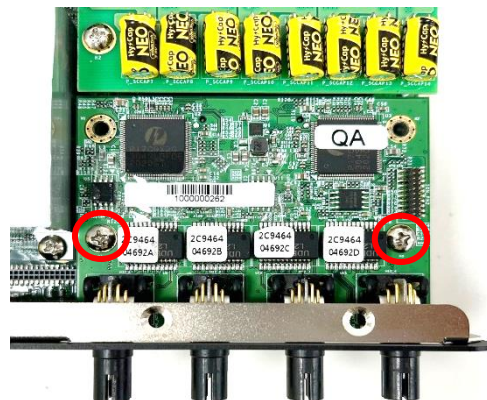

Step 5. Attach the assembled M12 I/O bracket on to the system, and fasten the hex nuts to fix it.

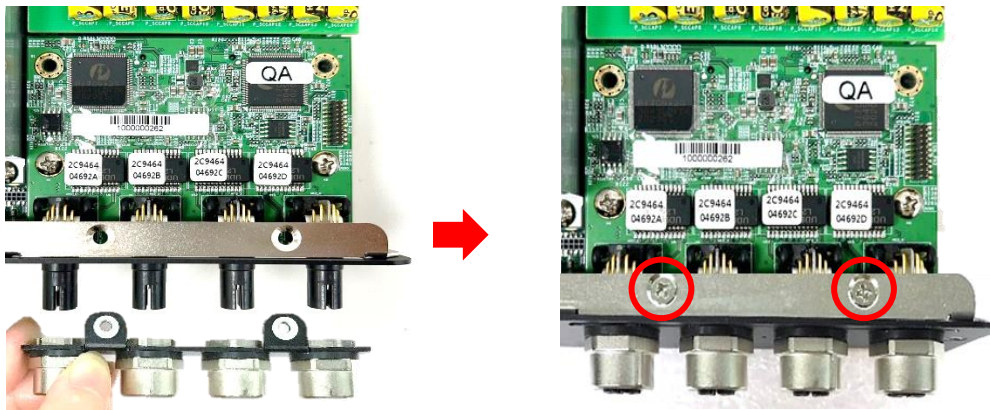

Step 6. Tie the rubber rings back to each M12 LAN port.

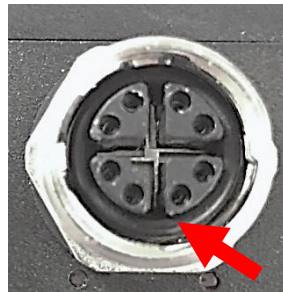

### 3.15.4 CMI-10GLAN04-R10/UB1528-R11

Step 1. Locate the BTB\_FH1 connector of the CMI module on the top side of system.

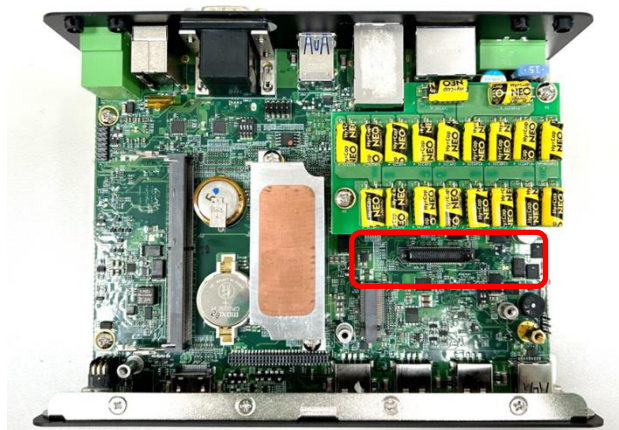



Step 2. Loosen the 2 screws and remove the front bezel.

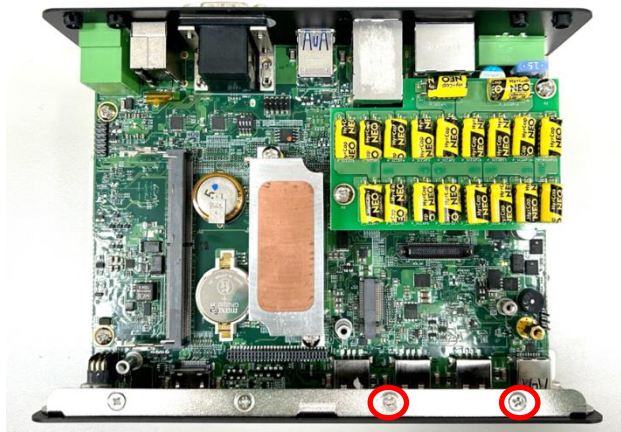

Step 3. Locate the chip place on the CMI-10GLAN module marked by red square. Paste the thermal pad on it carefully.

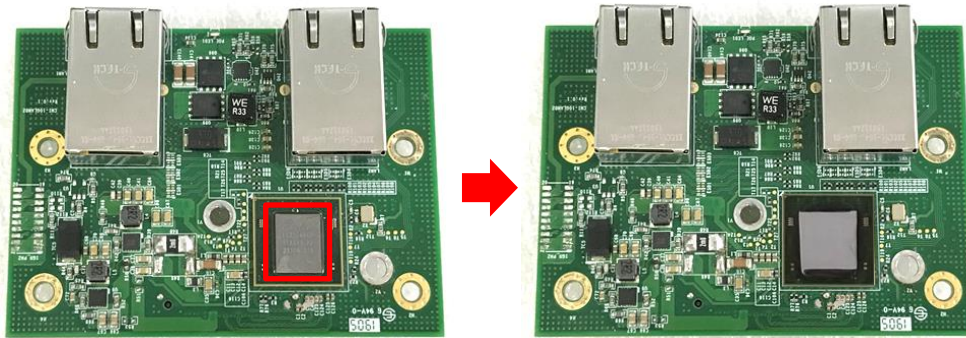

**CAUTION  
(ATTENTION)**

**Before putting on the thermal block (in the next step), please make sure the protective film on the Thermal Pad has been removed!**

**(Avant de mettre le bloc thermique (à l'étape suivante), veuillez vous assurer que le film protecteur sur le coussin thermique a été retiré!)**

Step 4. Put on the heatsink and turn over the module. Fasten the 3 screws (M3X5L) to fix the heatsink.

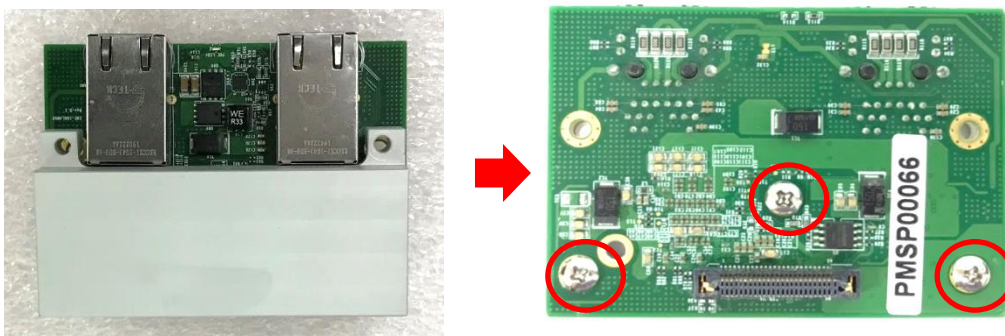

Step 5. Insert the CMI module vertically into the female connector on system's mainboard until it's connected firmly and fasten the 2 screws (M3X12L) to fix it.

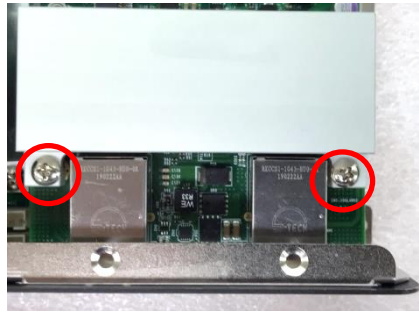

Step 6. Paste the thermal pad onto the heatsink carefully.



**CAUTION  
(ATTENTION)**

**Before assembling the system's chassis cover, please make sure the colorless protective film on the Thermal Pad has been removed! The yellow surface is part of the thermal pad. Do not tear it off as it would affect the thermal conductivity.**  
**(Avant d'assembler le capot du châssis du système, assurez-vous que le film protecteur incolore sur le coussinet thermique a été retiré ! La surface jaune fait partie du coussinet thermique. Ne le déchirez pas, car cela affecterait la conductivité thermique.)**

Step 7. Attach the I/O bracket on to the system, and fasten the two screws to fix it.

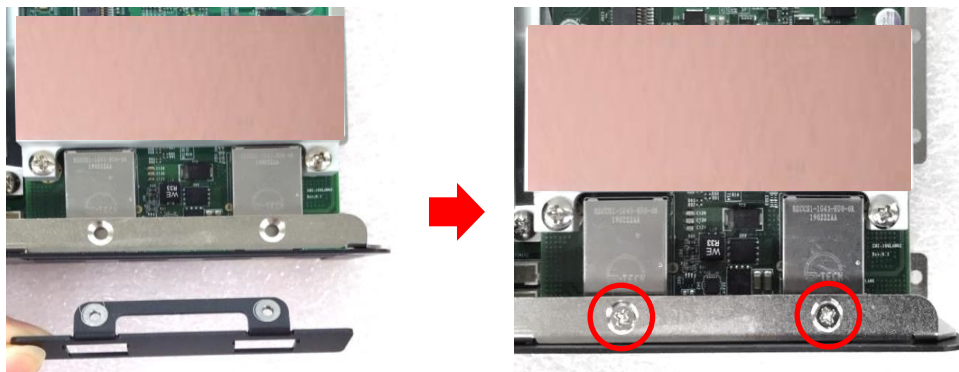

Step 8. Fasten the 4 D-Sub jack screws to fix the module. Then the installation of the module is complete.

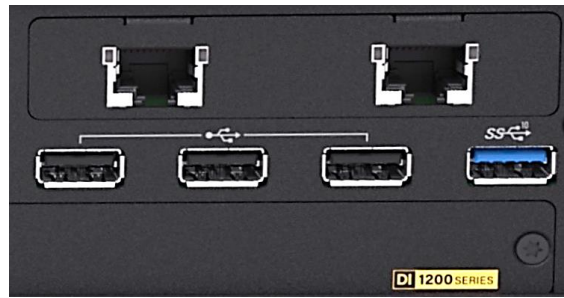

After installing the CMI-10GLAN04-R10 module, users need to enter BIOS > Chipset > [PCH-IO Configuration](#) page, and change the [BTB\_FH1 Mode Selection] setting from default mode [4x1] to mode [1x4] to enable the function of the module.

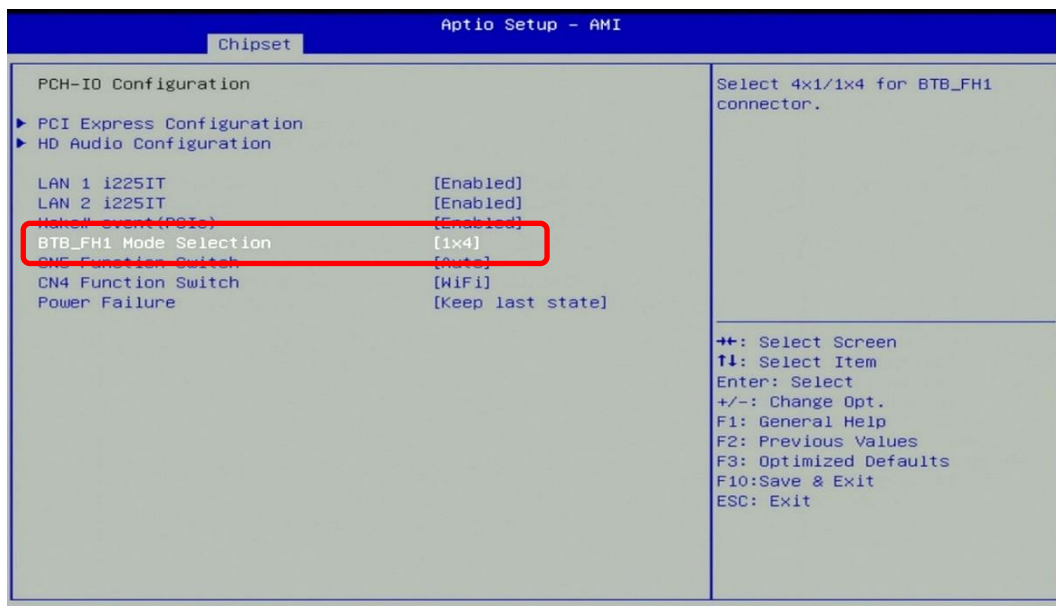

### 3.15.5 CMI-COM05-R10/UB1503-R11

Step 1. Locate the BTB\_FH2 connector of the CMI module on the top side of system.

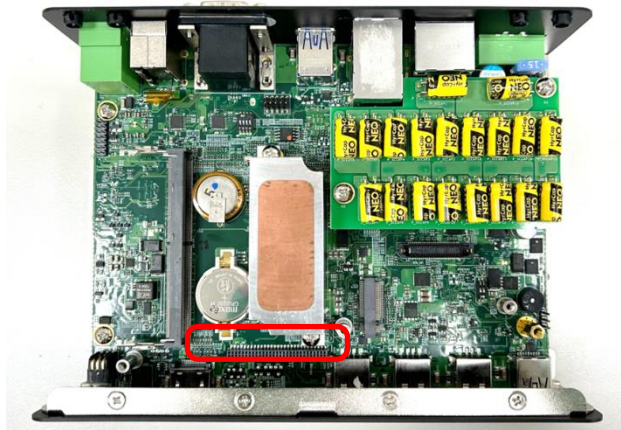

Step 2. Loosen the 2 screws and remove the front bezel.

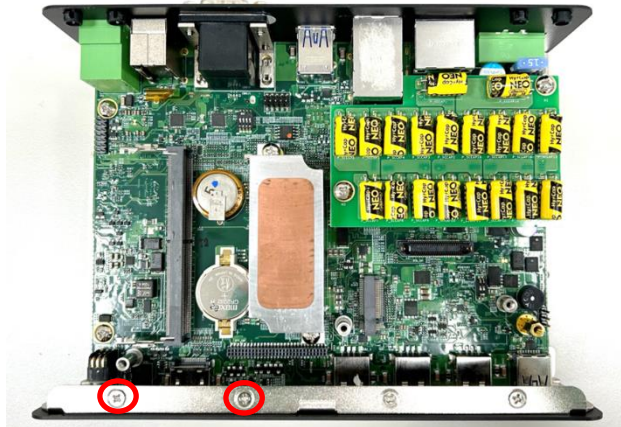

Step 3: Align the pins on the module with the connector on the left side as indicated, and then insert the CMI module vertically until it is securely connected with ensuring that the screw holes are properly aligned.

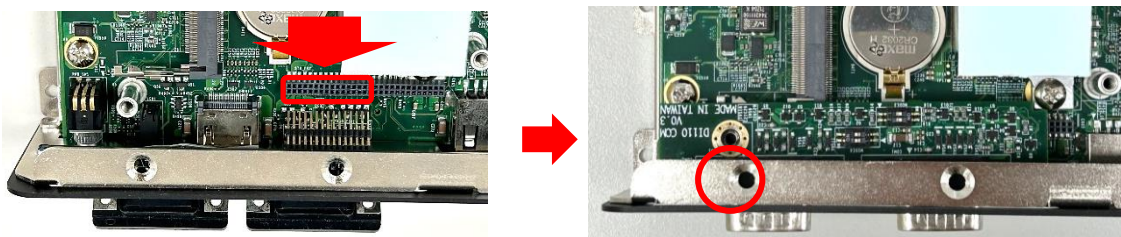

Step 4. Fasten the screw to secure it in place.



Step 5. Attach the I/O bracket on to the system, and fasten the two screws to fix it.

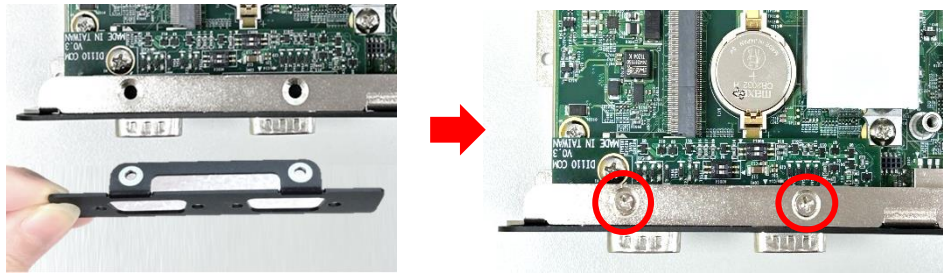

Step 6. Fasten the 4 D-Sub jack screws to fix the module. Then the installation of the module is complete.



After installing CMI-COM05-R10 module, users are required to navigate to BIOS > Advanced Setup > [F81966 Super IO Configuration](#) to verify the presence of the items related to the CMI-COM05-R10 module, specifically 'Serial Port 3 Configuration' and 'Serial Port 4 Configuration'.

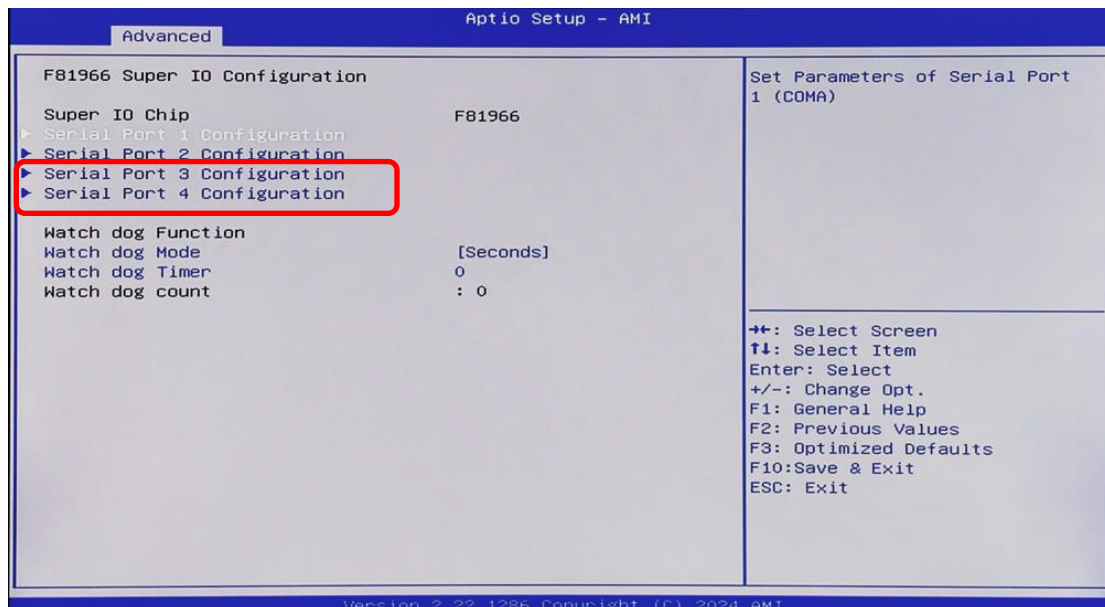

### 3.15.6 CMI-DIO05-R10/UB1518-R10

Step 1. Locate the BTB\_FH2 connector of the CMI module on the top side of system.



Step 2. Loosen the 2 screws and remove the front bezel.

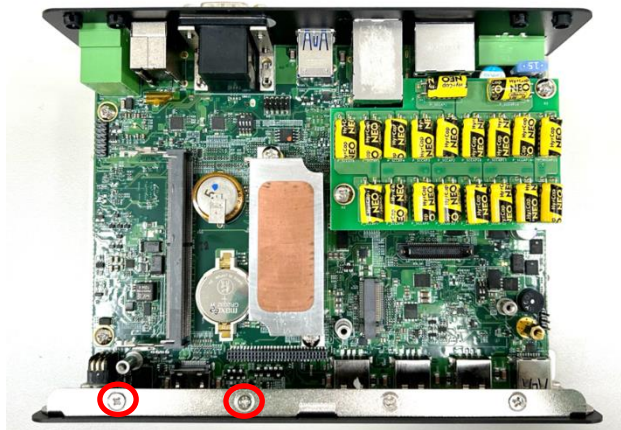

Step 3: Align the pins on the module with the connector on the left side as indicated, and then insert the CMI module vertically until it is securely connected with ensuring that the screw holes are properly aligned.

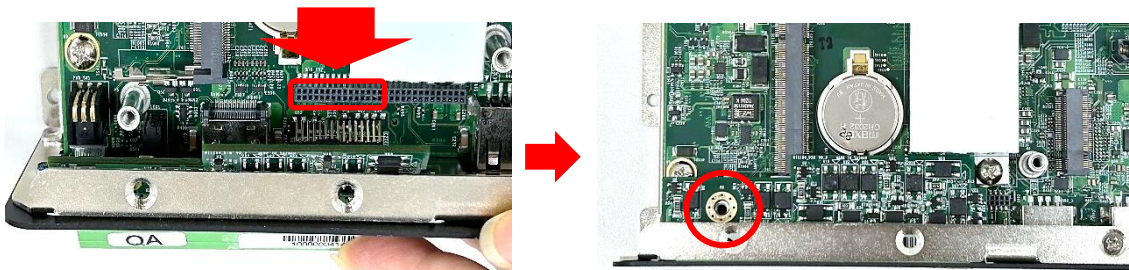

Step 4. Fasten the screw to secure it in place.



Step 5. Attach the I/O bracket on to the system, and fasten the two screws to fix it.

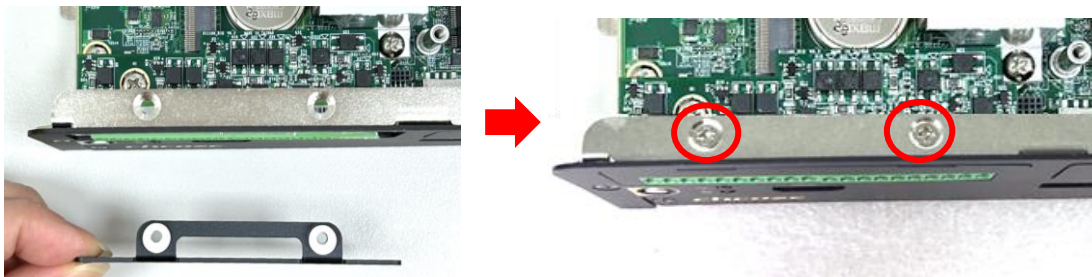

Step 6. Then the installation of the module is complete.



### 3.15.7 CMI-DP02/UB1506-R10

Step 1. Locate the BTB\_FH2 connector of the CMI module on the top side of system.



Step 2. Loosen the 2 screws and remove the front bezel.

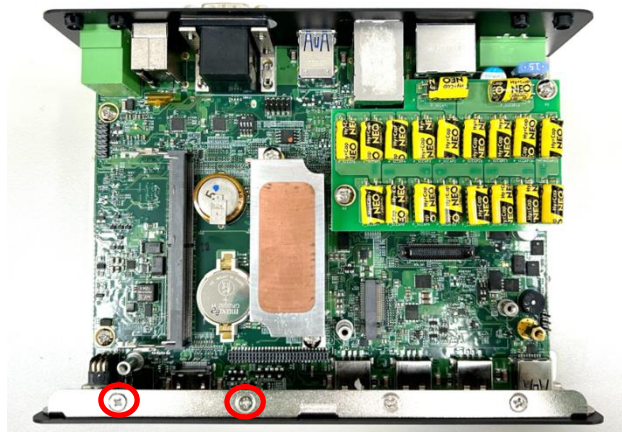

Step 3: Align the pins on the module with the connector on the right side as indicated, and then insert the CMI module vertically until it is securely connected with ensuring that the screw holes are properly aligned.

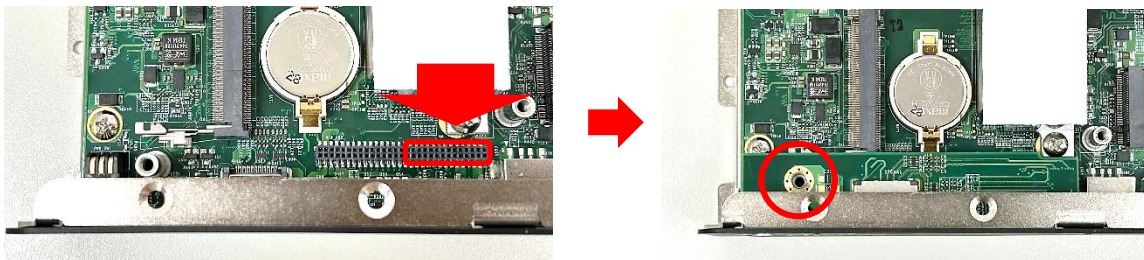

Step 4. Fasten the screw to secure it in place.





Step 5. Attach the I/O bracket on to the system, and fasten the two screws to fix it.

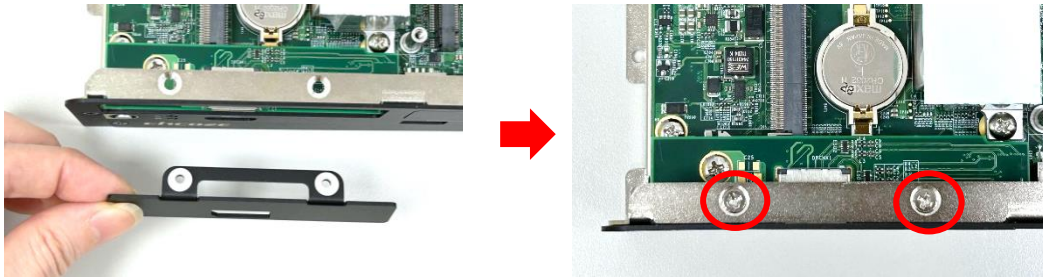

Step 6. Then the installation of the module is complete.



Please ensure the [Graphics Configuration](#) in the BIOS is set appropriately for successful display from this module.

### 3.15.8 CMI-HD04/UB1508-R10

Step 1. Locate the BTB\_FH2 connector of the CMI module on the top side of system.



Step 2. Loosen the 2 screws and remove the front bezel.

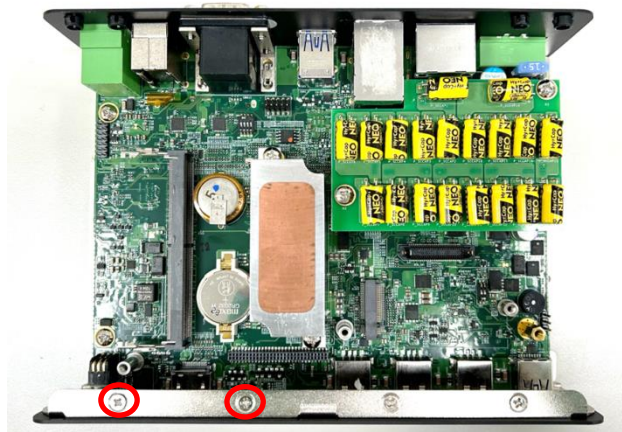

Step 3: Align the pins on the module with the connector on the right side as indicated, and then insert the CMI module vertically until it is securely connected with ensuring that the screw holes are properly aligned.

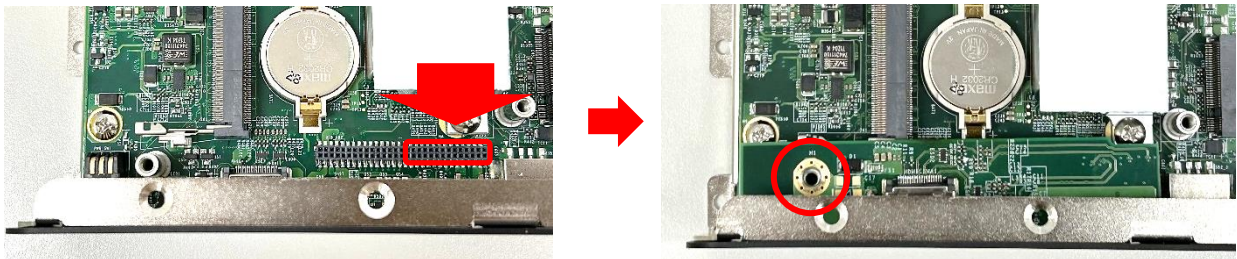

Step 4. Fasten the screw to secure it in place.



Step 5. Attach the I/O bracket on to the system, and fasten the two screws to fix it.

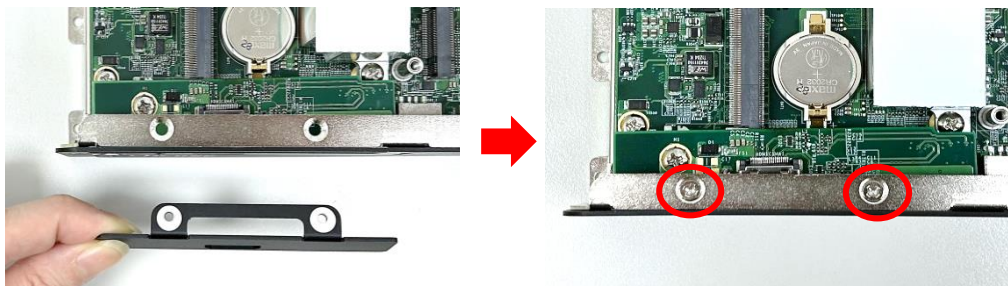

Step 6. Then the installation of the module is complete.



Please ensure the [Graphics Configuration](#) in the BIOS is set appropriately for successful display from this module.

### 3.15.9 CMI-VGA02/UB1516-R10

Step 1. Locate the BTB\_FH2 connector of the CMI module on the top side of system.



Step 2. Loosen the 2 screws and remove the front bezel.

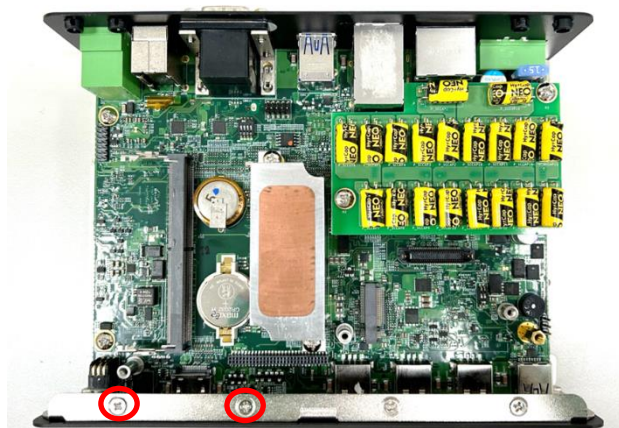

Step 3: Align the pins on the module with the connector on the right side as indicated, and then insert the CMI module vertically until it is securely connected with ensuring that the screw holes are properly aligned.

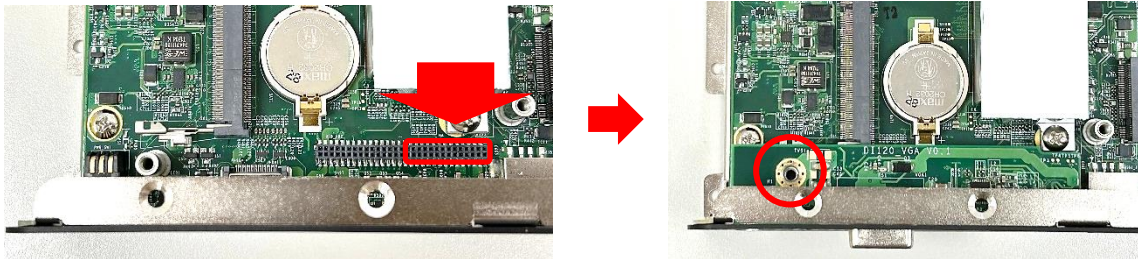

Step 4. Fasten the screw to secure it in place.

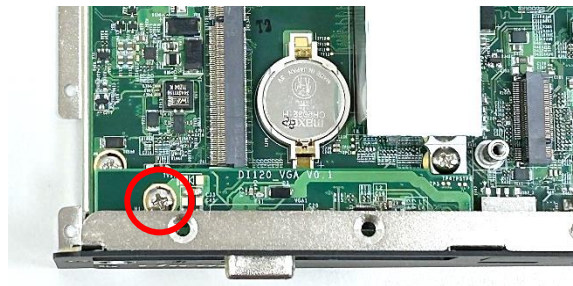

Step 5. Attach the I/O bracket on to the system, and fasten the two screws to fix it.

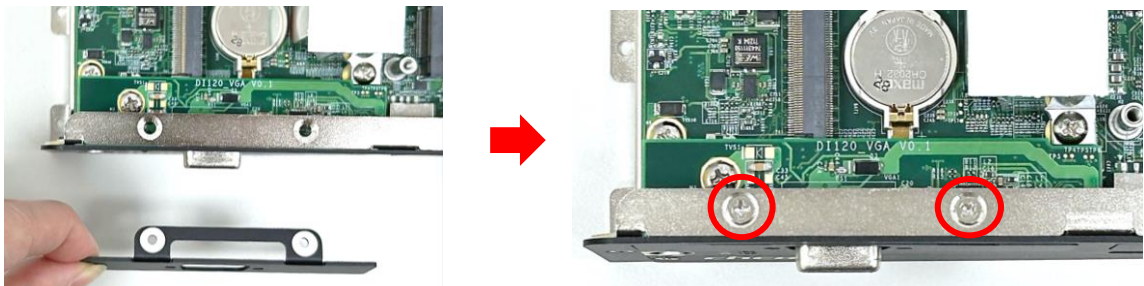

Step 6. Fasten the 2 D-Sub jack screws to fix the module. Then the installation of the module is complete.



Please ensure the [Graphics Configuration](#) in the BIOS is set appropriately for successful display from this module.

## 3.16 Installing CFM Modules

### 3.16.1 CFM-IGN102

Step 1. Locate the IGN\_PH1 connector on the bottom side of the system.

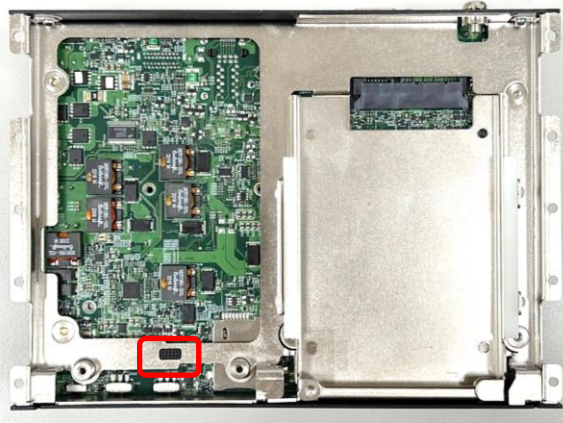

Step 2. Insert the connector of IGN module to the female connector on system motherboard. (Make sure all the pins of IGN module's connector are firmly connected.)

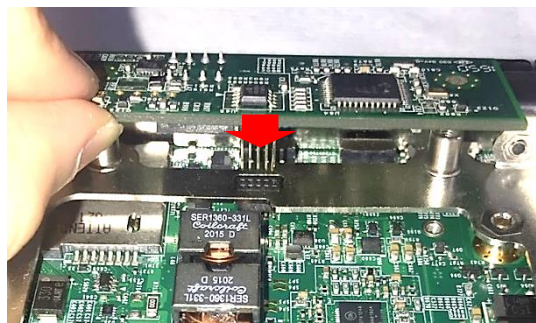

Step 3. Fasten the two screws to secure the power ignition board.



Step 4. Next, you will find the function switches for the IGN module in the maintenance area.

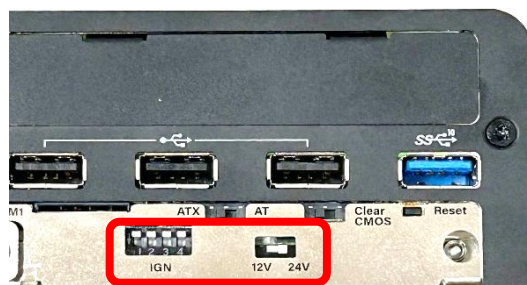

### 3.16.2 CFM-PoE06-R10

CFM-PoE06-R10 module can be installed on CMI-LAN01-R12 module, CMI-M12LAN01-R12 module or CMI-XM12LAN01-R10 module. When using CMI-LAN01-R12 module, please paste the shading tape to the place which was marked by red frame. (Watch out not to block the LED.) Otherwise, please skip this step. In this chapter, CMI-M12LAN01-R12 module will be taken as an example to demonstrate how to install CFM-PoE06 on it.

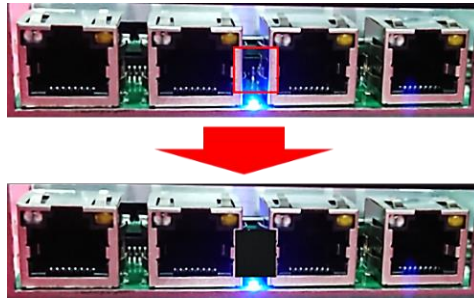

Step 1. Penetrate the copper pillars through the two holes on the LAN module, and fasten each copper pillar by the hex nut.

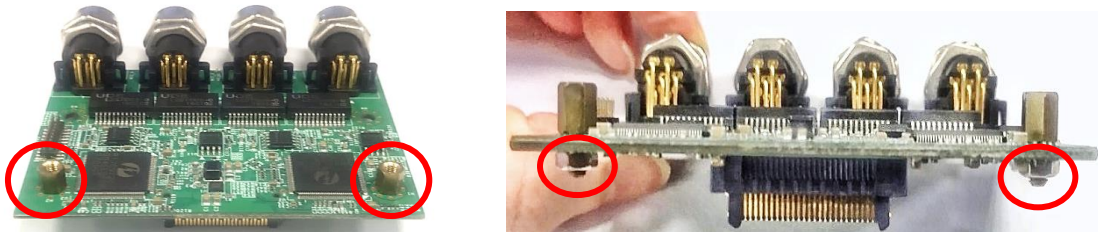

Step 2. Insert the LAN module vertically to the female connector on system's mainboard until it is connected firmly, and fasten the two copper pillars.

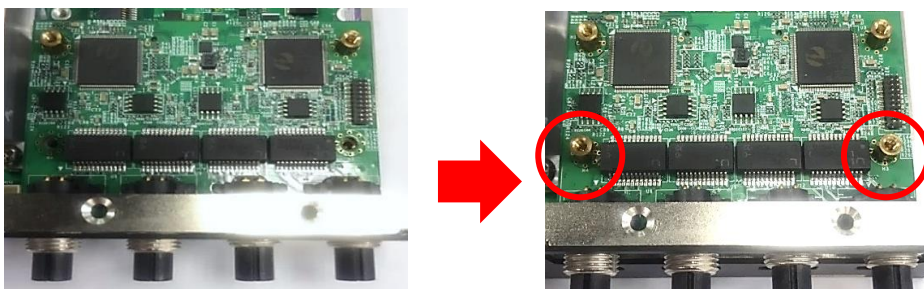

Step 3. Insert the CFM-PoE06 module vertically into the female connector on CMI module until it's connected firmly.

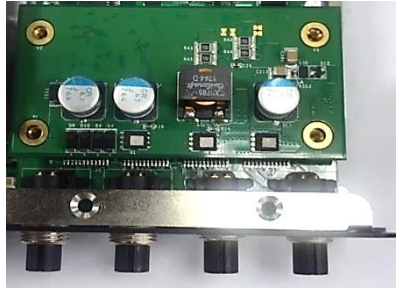

Step 4. Turn over the heatsink of CFM-PoE06 and locate the two places marked by red squares. And then paste two thermal pads for CFM-PoE06 onto the heatsink carefully.

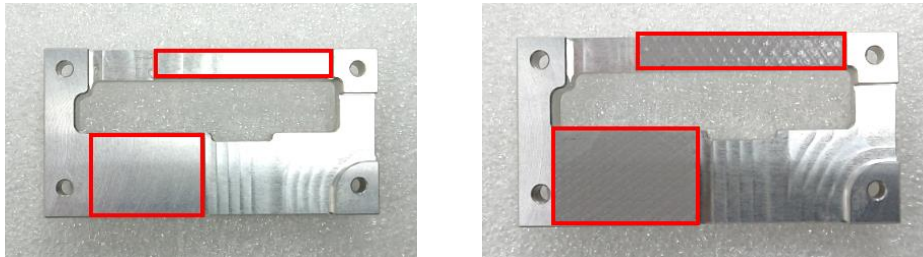

CAUTION  
(ATTENTION)

Before putting on the thermal block (in the next step), please make sure the protective film on the Thermal Pad has been removed!

(Avant de mettre le bloc thermique (à l'étape suivante), veuillez vous assurer que le film protecteur sur le coussin thermique a été retiré!)

Step 6. Paste the heatsink onto the CFM-PoE06 module carefully, and fasten two screws to fix it.

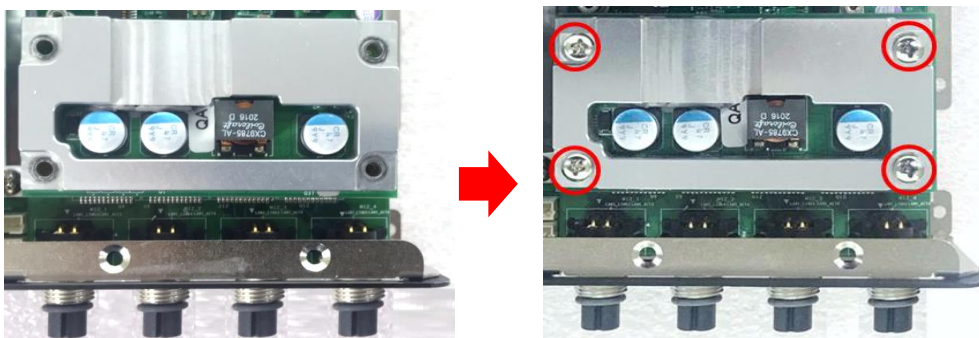

Step 7. Paste the last thermal pad onto the heatsink carefully, and then continue the step 5~ step 6 in chapter 3.14.3.

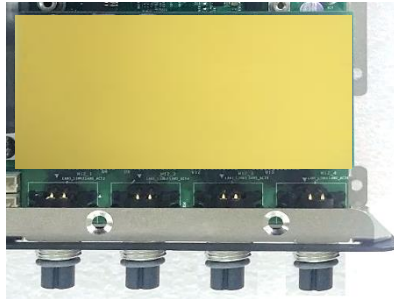

**CAUTION  
(ATTENTION)**

**Before assembling the system's chassis cover, please make sure the colorless protective film on the Thermal Pad has been removed! The yellow surface is part of the thermal pad. Do not tear it off as it would affect the thermal conductivity.**  
**(Avant d'assembler le capot du châssis du système, assurez-vous que le film protecteur incolore sur le coussinet thermique a été retiré ! La surface jaune fait partie du coussinet thermique. Ne le déchirez pas, car cela affecterait la conductivité thermique.)**

*Once the steps are finished, after system power on, PoE LED (on CMI-LAN, CMI-M12 LAN, or CMI-XM12 LAN module) will light blue as shown below.*







# **Chapter 4**

## **BIOS Setup**

## 4.1 BIOS Introduction

The BIOS (Basic Input/ Output System) is a program located on a Flash Memory on the motherboard. When you start the computer, the BIOS program will gain control. The BIOS first operates an auto-diagnostic test called POST (power on self-test) for all the necessary hardware, it detects the entire hardware device and configures the parameters of the hardware synchronization.

### BIOS Setup

Power on the computer and by pressing <Del> immediately allows you to enter Setup. If the message disappears before your respond and you still wish to enter Setup, restart the system to try again by turning it OFF then ON or pressing <Ctrl>, <Alt> and <Delete> keys.

Control Keys	
<←> <→>	Move to select screen
<↑> <↓>	Move to select item
<Esc>	Quit the BIOS Setup
<Enter>	Select item
<Page Up/>	Increases the numeric value or makes changes
<Page Down/->	Decreases the numeric value or makes changes
<Tab>	Select setup fields
<F1>	General help
<F2>	Previous value
<F3>	Load Optimized defaults
<F10>	Save configuration and Exit

### Main Menu

The main menu lists the setup functions you can make changes to. You can use the arrow keys ( ↑ ↓ ) to select the item. The on-line description of the highlighted setup function is displayed at the bottom of the screen.

### Sub-Menu

If you find a right pointer symbol appears to the left of certain fields that means a sub-menu can be launched from this field. A sub-menu contains additional options for a field parameter. You can use arrow keys ( ↑ ↓ ) to highlight the field and press <Enter> to call up the sub-menu. Then you can use the control keys to enter values and move from field to field within a sub-menu. If you want to return to the main menu, just press the <Esc >.

## 4.2 Main Setup

Press <Del> to enter BIOS CMOS Setup Utility, the Main Menu (as shown below) will appear on the screen. Use arrow keys to move among the items and press <Enter> to accept or enter a sub-menu.

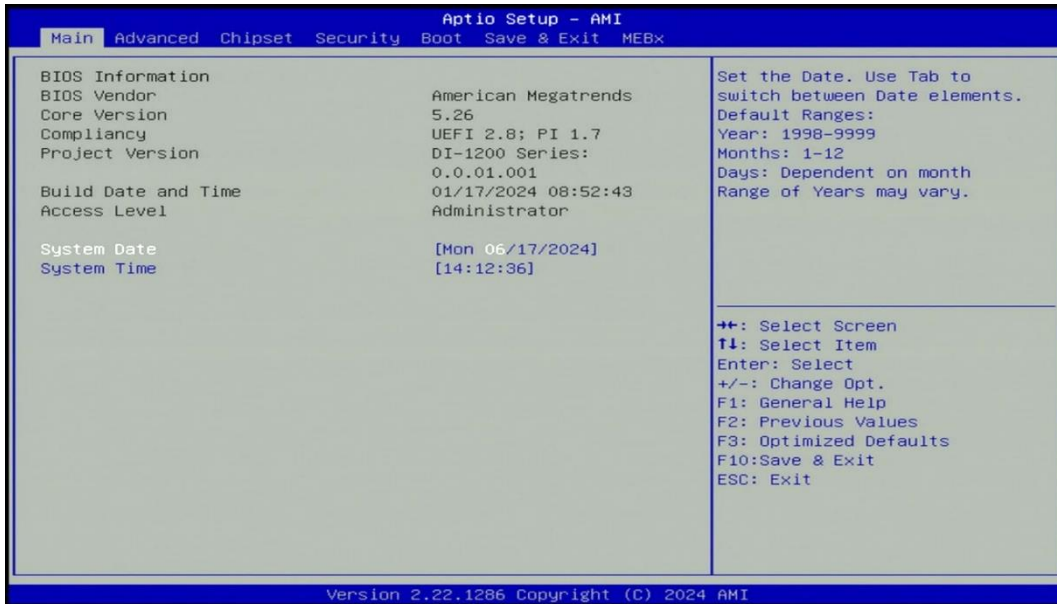

### ■ System Date

Set the date. Please use <Tab> to switch between date elements.

### ■ System Time

Set the time. Please use <Tab> to switch between time elements.

## 4.3 Advanced Setup

This section allows you to configure and improve your system and allows you to set up some system features according to your preference.

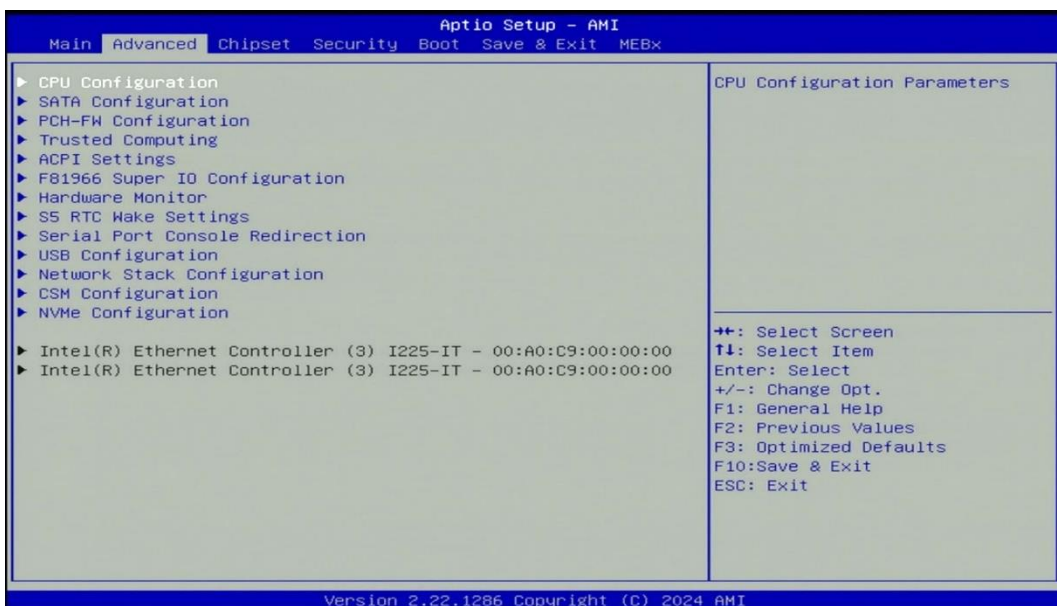

### 4.3.1 CPU Configuration



#### ■ Intel (VMX) Virtualization Technology [Enabled]

Enables or disables Intel Virtualization Technology. Virtualization enhanced by Intel Virtualization Technology will allow a platform to run multiple operating systems and applications in independent partitions. With virtualization, one computer system can function as multiple virtual systems.

#### ■ Active Performance-cores

Allows you to choose the number of active performance cores.

Configuration options: [All] [1].

#### ■ Active Efficient-cores

Allows you to choose the number of active efficient cores.

Configuration options: [All] [7] [6] [5] [4] [3] [2] [1].

#### ■ Hyper-threading

Enables or disables for Hyper-Threading Technology.

### 4.3.2 SATA Configuration



- **SATA Controller(s) [Enabled]**

Enables or disables SATA device.

- **SATA Mode Selection [AHCI]**

Allows you to select which mode SATA controller will operates.

Configuration options: [AHCI]

- **Serial ATA Port 0**

  - Port 0 [Enabled]**

Enables or disables SATA Port 0.

- **Serial ATA Port 1**

  - Port 1 [Enabled]**

Enables or disables SATA Port 1.

### 4.3.3 PCH-FW Configuration



## ■ Firmware Update Configuration

### Configure Management Engine Parameters

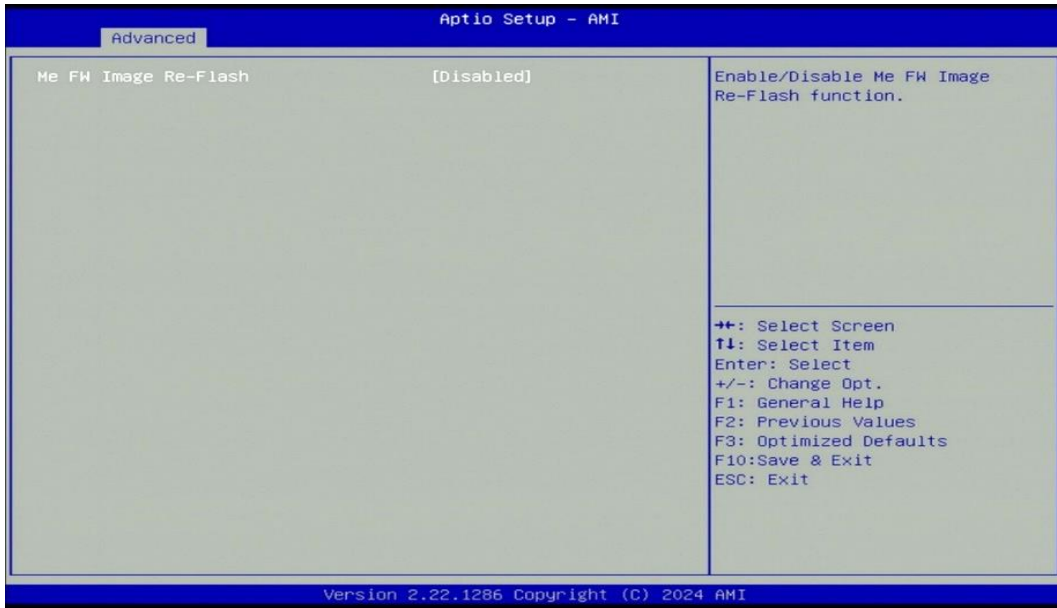

## ■ Me FW Image Re-Flash [Disabled]

Enables or disables ME firmware Image Re-Flash function.

### 4.3.4 Trusted Computing Settings

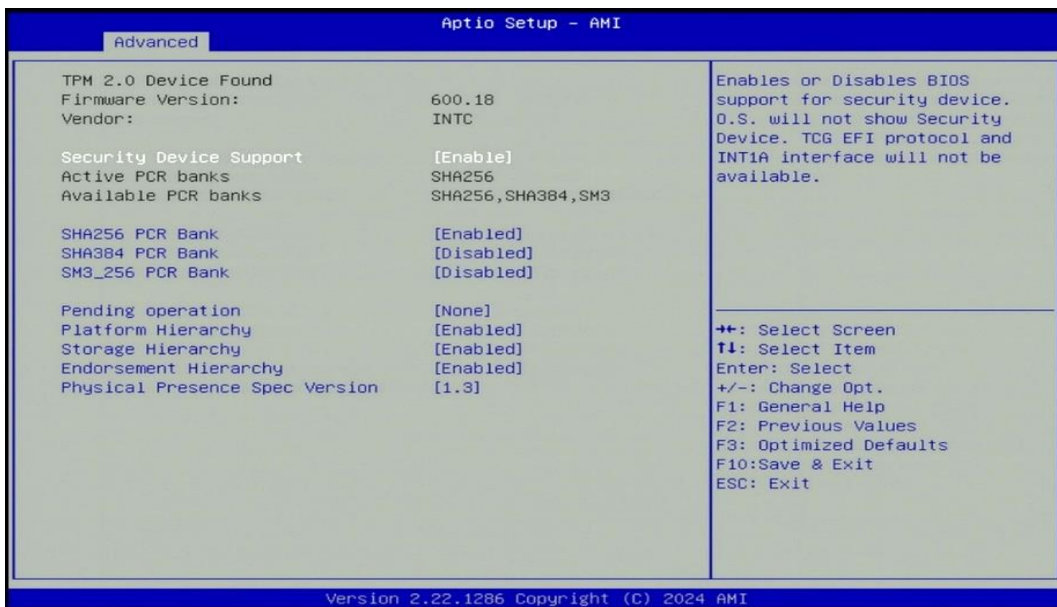

## ■ Security Device Support [Enabled]

Enables or disables Security Device Support function.

## ■ SHA256 PCR Bank [Enabled]

Enables or disables SHA256 PCR Bank function.

## ■ SHA384 PCR Bank [Disabled]

Enables or disables SHA384 PCR Bank function.

#### ■ **SM3\_256 PCR Bank [Disabled]**

Enables or disables SM3\_256 PCR Bank function.

#### ■ **Pending Operation [None]**

Allows you to select which mode Pending Operation will operate.

Configuration options: [None], [TPM Clear]

#### ■ **Platform Hierarchy [Enabled]**

Enables or disables Platform Hierarchy function.

#### ■ **Storage Hierarchy [Enabled]**

Enables or disables Storage Hierarchy function.

#### ■ **Endorsement Hierarchy [Enabled]**

Enables or disables Endorsement Hierarchy function.

#### ■ **Physical Presence Spec Version [1.3]**

Allows you to select which mode Physical Presence Spec Version will operate.

Configuration options: [1.2], [1.3]

### 4.3.5 ACPI Settings



#### ■ **Enable Hibernation [Enabled]**

Enables or disables system ability to hibernate state (OS/S4 state). This option may not be effective with some OS.

#### ■ **ACPI Sleep State [S3 (Suspend to RAM)]**

Allows users to select the highest Advanced Configuration Power Interface® (ACPI) sleep state that system will enter when suspend button is pressed.

[Suspend Disabled]: Disables entering suspend state.

[S3 (suspend to RAM)]: Enables suspend to RAM state.

### 4.3.6 F81966 Super IO Configuration

Set Parameters of Serial Ports. User can Enable/Disable the serial port and select an optimal setting for the Super IO Device.



#### ■ Serial Port 1 Configuration.

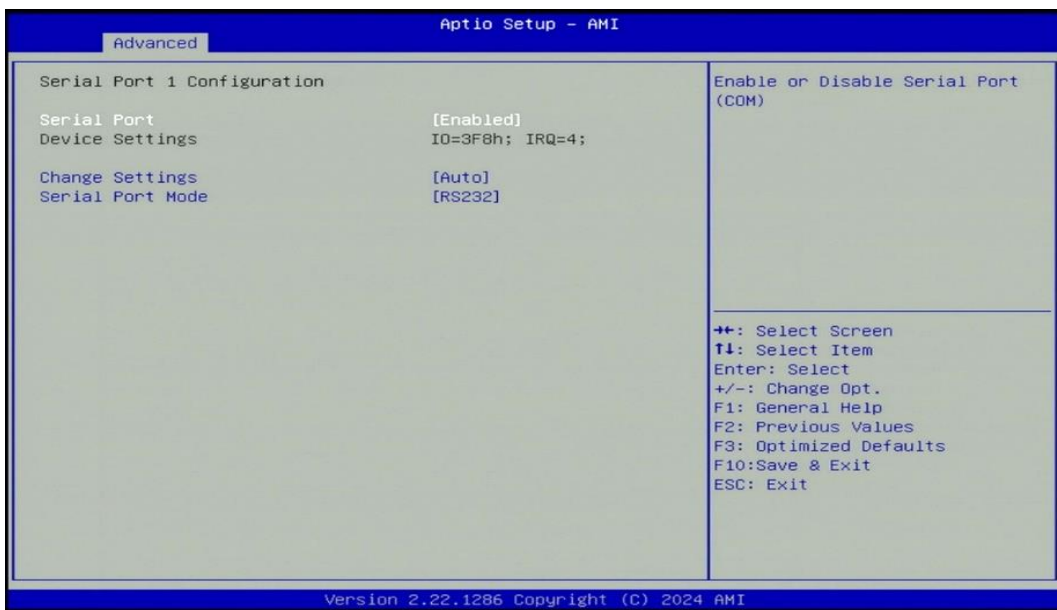

#### ■ Serial Port [Enabled]

Enables or disables serial port.

#### ■ Change Settings [Auto]

Allows you to change the IO Address & IRQ settings of the specified serial port.

#### ■ Serial Port Mode [RS232]

Allows you to select Serial Port Mode.



Configuration options: [RS232] [RS422/RS485 Full Duplex] [RS485 Half Duplex]

### ■ Watch Dog Mode [Sec]

Allows to set watchdog timer unit <Sec> or <Min>.

### ■ Watch Dog Timer [0]

Allows you to set watchdog timer's value in the range of 0 to 255.

## 4.3.7 Hardware Monitor

This screen displays the current status of all monitored hardware devices/components such as voltages, temperatures.



### ■ External Smart Fan Function [Enabled]

Enables or disables External Smart Fan function.

### ■ External Smart Fan Configuration

Configure External Smart Fan Parameters.

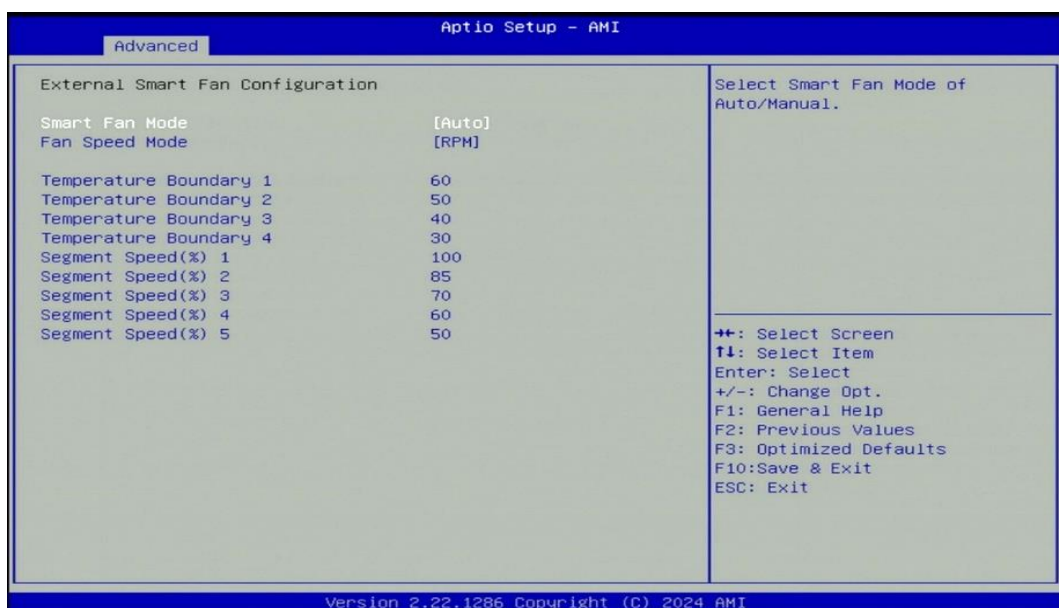

### ■ Smart Fan Mode [Auto]

Allows you to select Smart Fan Mode.

Configuration options: [Auto] [Manual]

### ■ Fan Speed Mode [RPM]

Allows you to select Fan Speed Mode.

Configuration options: [RPM] [Duty]

## 4.3.8 S5 RTC Wake Settings



### ■ Wake system from S5 [Disabled]

Enables or disables wake system from S5 (soft-off state).

[Disabled]: Disables wake system from S5.

[Fixed Time]: Sets a fixed time (HH:MM:SS) to wake system from S5.

[Dynamic Time]: Sets an increase minute(s) from current time to wake system from S5.

### 4.3.9 Serial Port Console Redirection

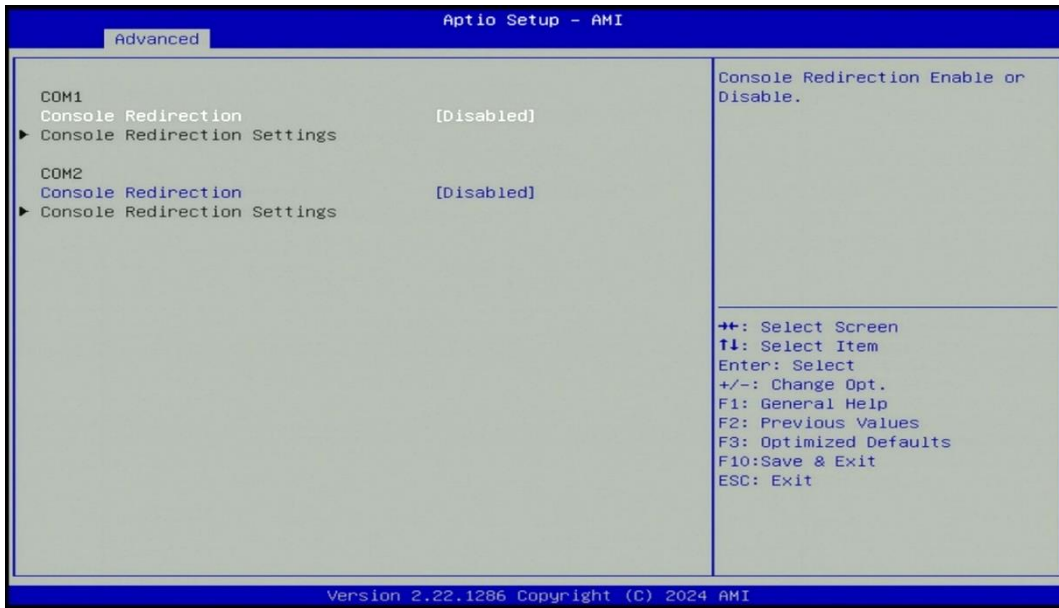

#### ■ Console Redirection [Disabled]

Allow users to enable or disable COM1, COM2 console redirection function.

### 4.3.10 USB Configuration

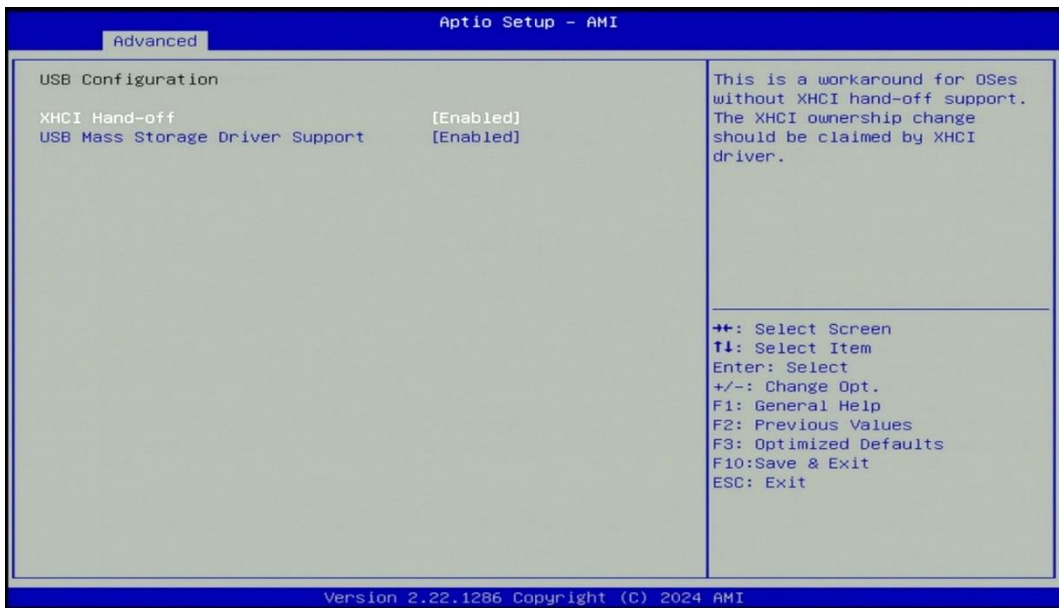

#### ■ XHCI Hand-off [Enabled]

Enables or disables XHCI (USB3.0) hand-off function. Use this feature as a workaround for operating systems without XHCI hand-off support.

#### ■ USB Mass Storage Driver Support [Enabled]

Enables or disables USB mass storage driver support.

### 4.3.11 Network Stack Configuration



#### ■ Network Stack [Disabled]

Enables or disables UEFI Network Stack.

### 4.3.12 CSM Configuration



#### ■ CSM Support [Disabled]

Enables or disables compatibility support module.

### 4.3.13 NVMe Configuration

The screen allows users to select options for the NVMe configuration, and change the value of the selected option. If there is NVMe Device detected, the options will show as the NVMe Device is found.



## 4.4 Chipset Setup

This section allows you to configure chipset related settings according to user's preference.

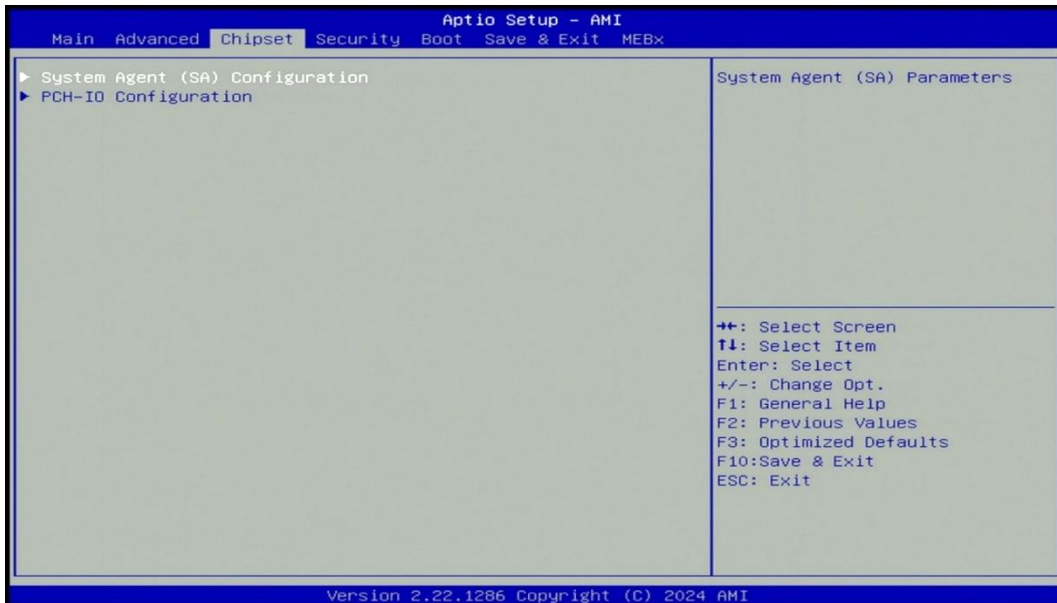

#### 4.4.1 System Agent (SA) Configuration

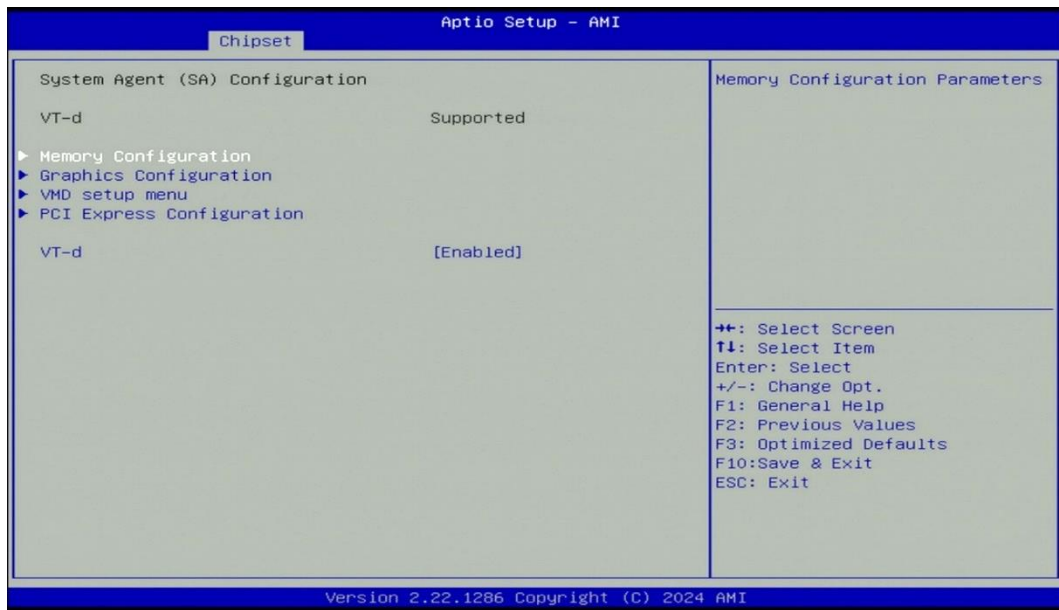

#### ■ Memory Configuration

This item displays detailed memory configuration in the system.



## ■ Graphics Configuration

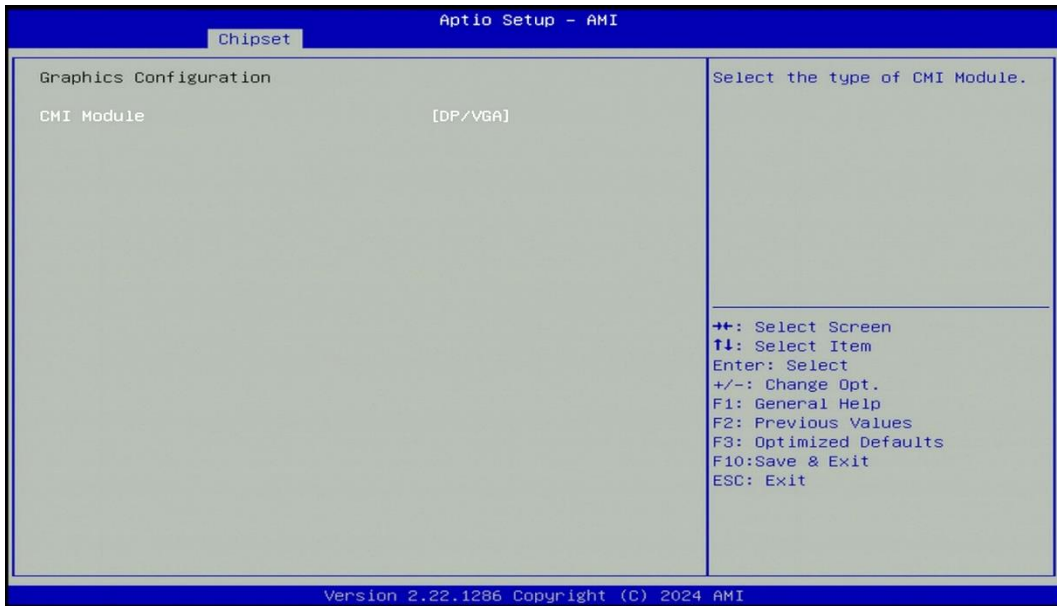

### ■ CMI Module [DP/VGA]

This option enables users to choose the type of CMI Module. The default setting is DP/VGA. If the CMI-HDMI module is utilized, kindly ensure to configure this function as [HDMI] to ensure successful display from the CMI-HDMI module.

Configuration options: [DP/VGA] [HDMI]

## ■ VMD Configuration



### ■ Enable VMD controller [Disable]

Enable or Disable to VMD controller.

## ■ PCI Express Configuration



### ■ PCI Express Root Port (CN4)

#### ■ PCI Express Root Port [Enabled]

Enables or disables PCI Express Root Port.

#### ■ PCIe Speed [Auto]

Allows you to select PCI Express interface speed.

Configuration options: [Auto] [Gen1] [Gen2] [Gen3] [Gen4].

### ■ VT-d [Enabled]

Enables or disables Intel® Virtualization Technology for Directed I/O (VT-d) capability.

## 4.4.2 PCH-IO Configuration





## ■ PCI Express Configuration

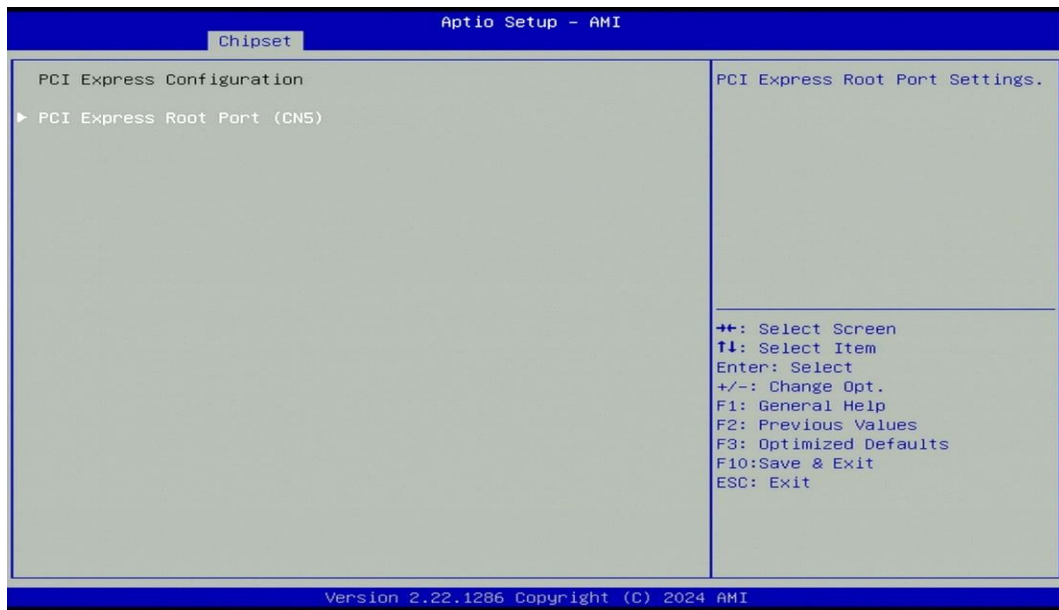

### ■ PCI Express Root Port (CN5)

#### ■ PCI Express Root Port [Enabled]

Enables or disables PCI Express Root Port.

#### ■ PCIe Speed [Auto]

Allows you to select PCI Express interface speed.

Configuration options: [Auto] [Gen1] [Gen2] [Gen3].

## ■ HD Audio Configuration

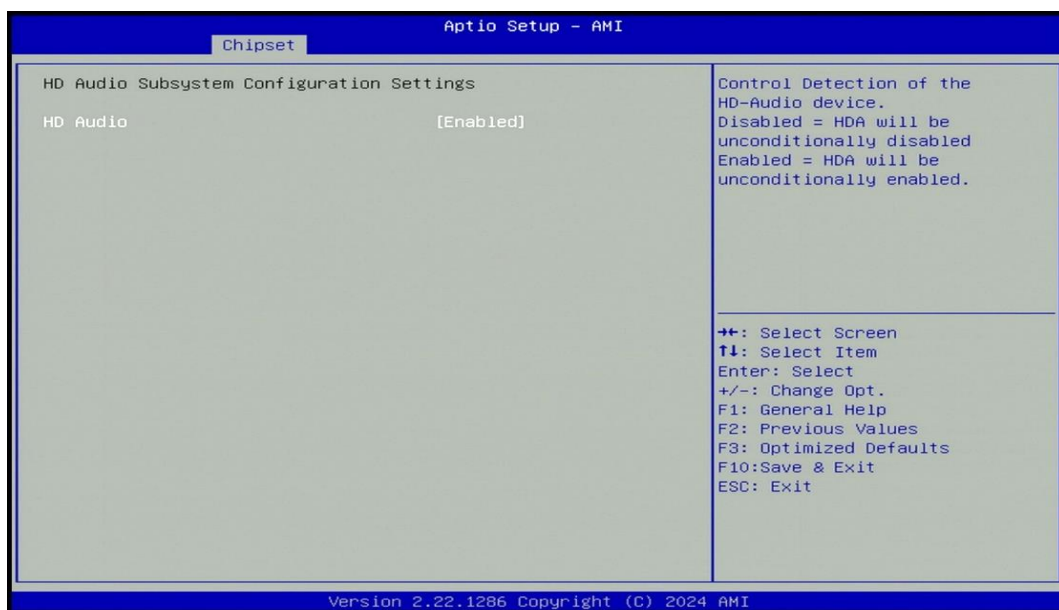

### ■ HD Audio [Enabled]

Enables or disables HD Audio function.

#### ■ LAN 1 i225IT [Enabled]

Enables or disables I210 LAN Controller.

#### ■ LAN 2 i225IT [Enabled]

Enables or disables I210 LAN Controller.

#### ■ Wake# event (PCIe) [Enabled]

Enables or disables Wake# event (PCIe).

#### ■ BTB\_FH1 Mode Selection [4x1]

Allows users to select [4x1] or [1x4] for BTB\_FH1 Mode.

#### ■ CN5 Function Switch [Auto]

Allows you to change **CN5 Function** as [Auto], [SSD-SATA], [SSD-PCIe], [WWAN-PCIe], or [WWAN-USB3].

#### ■ CN4 Function Switch [Wifi]

Allows you to change CN4 as [CNVi] or [WiFi].

#### ■ Power Failure [Keep last state]

Allows you to specify which power state system will enter when power is resumed after a power failure (G3 state).

[Always on]: Enters to power on state.

[Always off]: Enters to power off state.

[Keep last state]: Enters to the last power state before a power failure.

## 4.5 Security Setup

This section allows users to configure BIOS security settings.

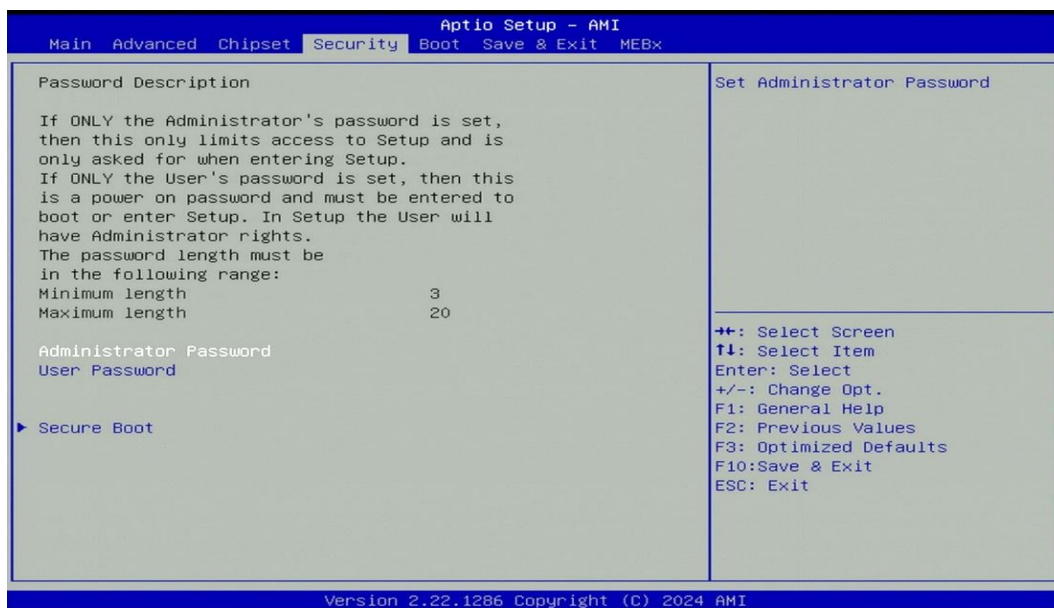

## ■ Administrator Password

Administrator Password controls access to the BIOS Setup utility.

## ■ User Password

User Password controls access to the system at boot and to the BIOS Setup utility.

## ■ Security Boot

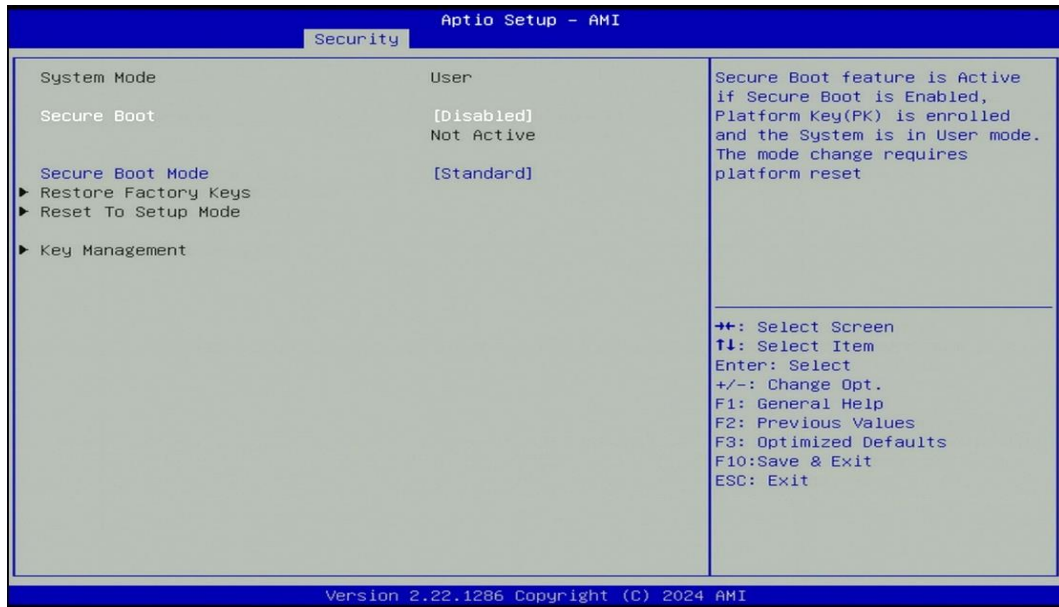

### ■ Secure Boot [Disabled]

Enable or disable Secure Boot function. (Enable this function to change the following settings.)

### ■ Secure Boot Mode [Standard]

Allows you to select Secure Boot Mode.

Configuration options: [Standard] [Custom].

## 4.6 Boot Setup

This section allows you to configure Boot settings.

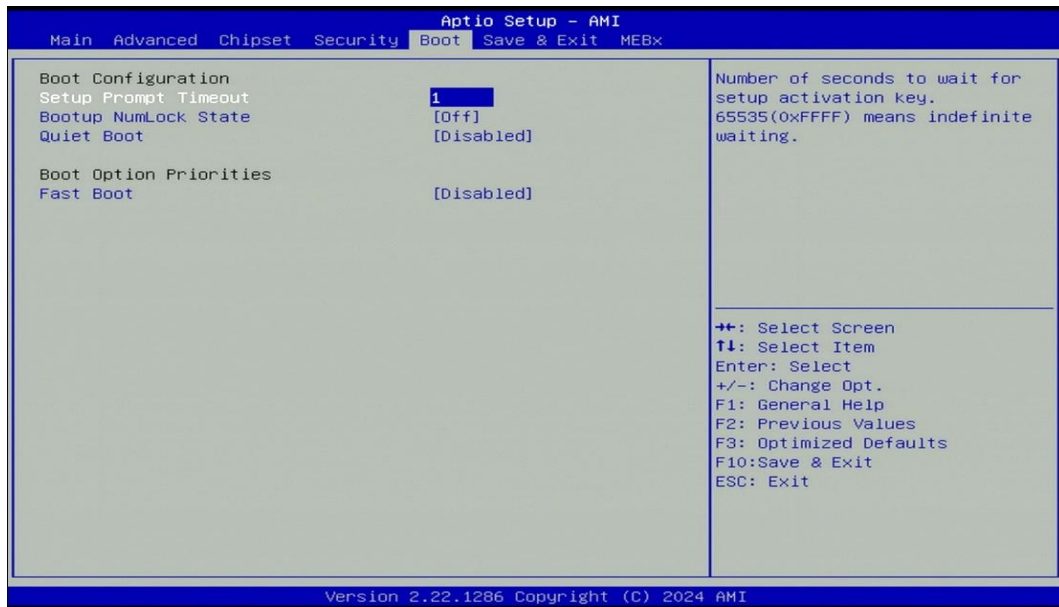

### ■ Setup Prompt Timeout [1]

Use this item to set number of seconds (1..65535) to wait for setup activation key.

### ■ Bootup NumLock State [Off]

Allows you to set NumLock key to [On] or [Off] state when system boots up.

### ■ Quiet Boot

Allows you to enable or disable Quiet Boot function.

### ■ Fast Boot

Allows you to enable or disable Fast Boot function. If enabled, system boots with initialization of a minimal set of devices required to launch active boot option.

## 4.7 Save & Exit

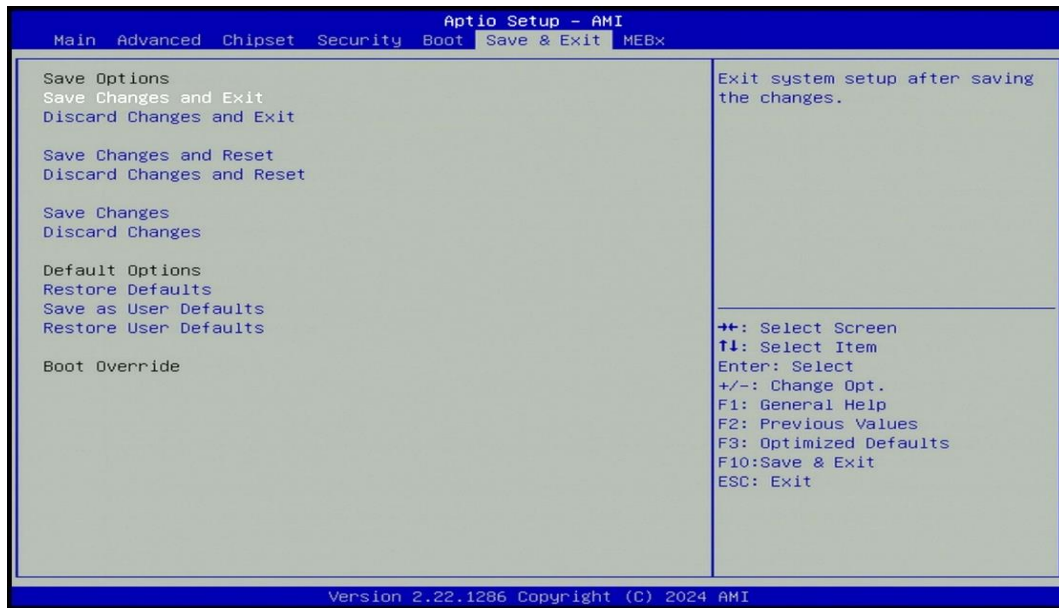

### ■ Save Changes and Exit

This item allows you to exit the system after saving changes.

### ■ Discard Changes and Exit

This item allows you to exit system setup without saving any changes.

### ■ Save Changes and Reset

This item allows you to reset the system after saving changes.

### ■ Discard Changes and Reset

This item allows you to reset system setup without saving any changes.

### ■ Save Changes

This item allows you to save changes.

### ■ Discard Changes

This item allows you to discard changes.

### ■ Restore Defaults

This item allows you to restore/ load default values for all the setup options.

### ■ Save as User Defaults

This item allows you to save the changes done so far as user defaults.

### ■ Restore User Defaults

This item allows you to restore the user defaults to all the setup options.

## 4.8 MEBx

This page is dedicated to configuring the ME function. After the system powers on, press the delete key promptly to access the BIOS menu, allowing users to view the following MEBx page.



Press enter key to enter the default password "admin" to enter the next step for password creation.

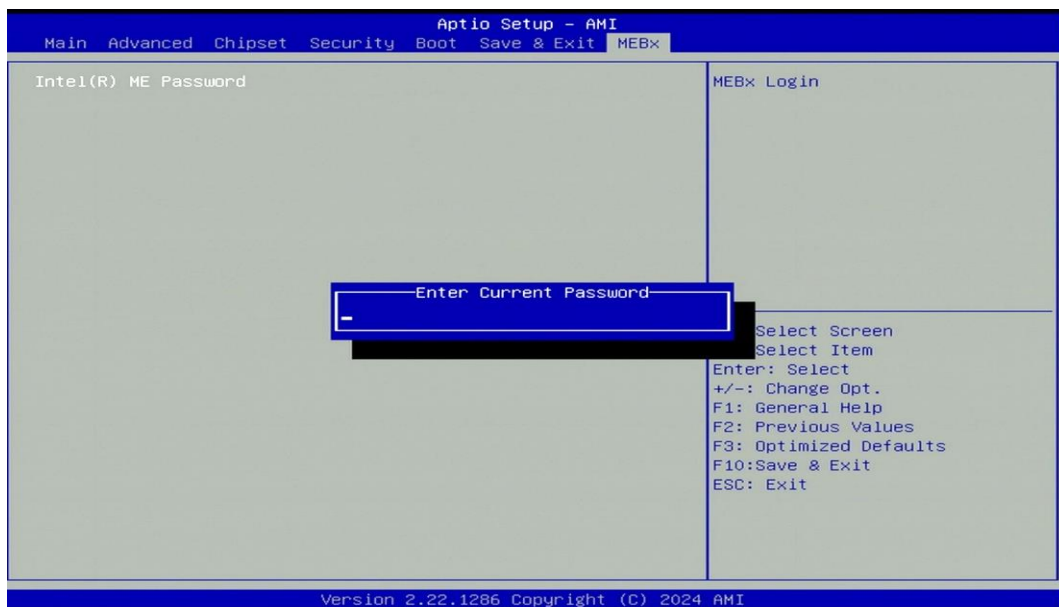

Create a new password using 8 characters including uppercase and lowercase letters, numbers and special symbols. (For example, "Abc123!!")

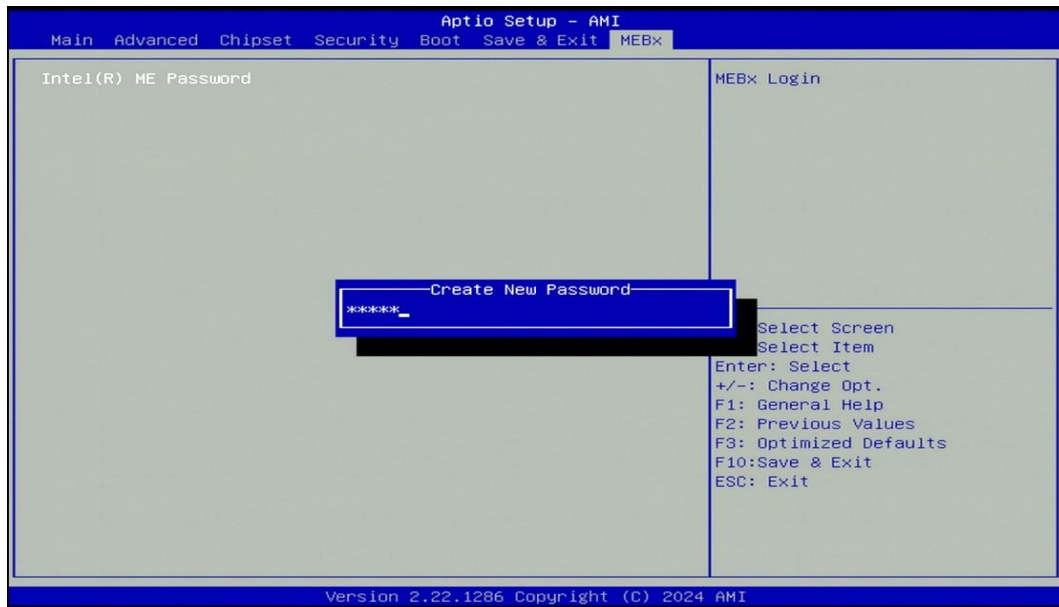

Enter the created password again for confirmation.



Afterward, you will be directed to the MEBx function setting page."

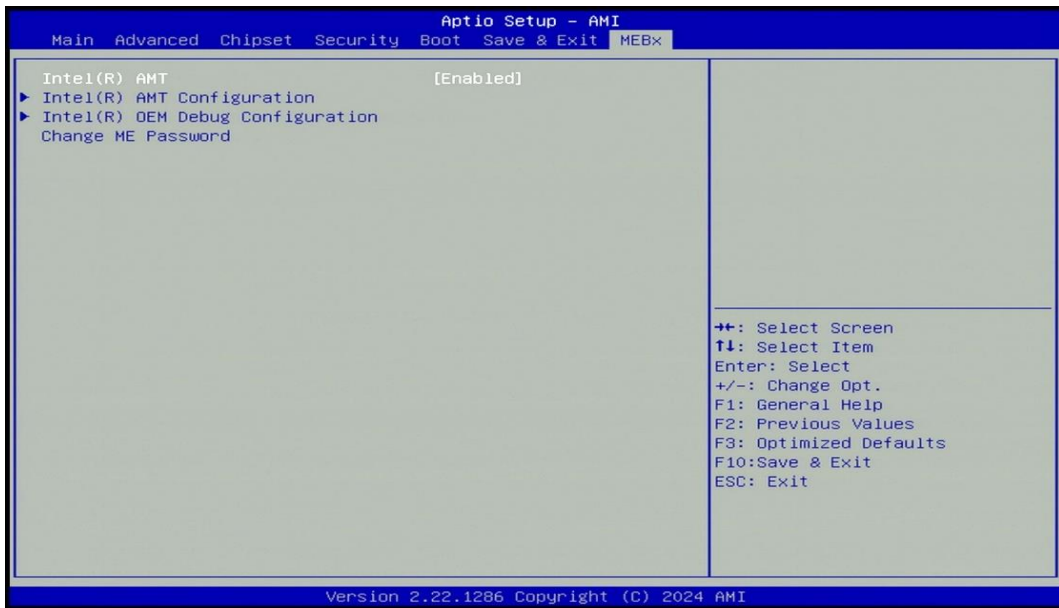





# **Chapter 5**

## **Product Application**

## 5.1 Where to download drivers?

Please go to the CINCOZE website to download the drivers for DI-1200 series.

## 5.2 Where to find the technical documents?

Please go to the [CINCOZE website](#) to find the technical documents for DI-1200 series.

Catalog	Document Title
Application Notes	DIO Application Guide
	DIO Technical Guide
	Instant Reboot Application Guide
	WDT Application Guide
	WDT Technical Guide
Configure & Installation	AT ATX Power Mode Function Manual
	BIOS Administrator User Password
	Clear CMOS Function Manual
	COM Port Function Manual
	CSM Function Manual
	Digital I/O Function Manual
	How to import Secure Boot Key?
	How to restore Windows image with Clonezilla?
	How to set TPM function under Windows?
	How to stop automatic driver update in Windows
	How to Update BIOS and ME under UEFI shell?
	How to Update BIOS under UEFI shell?
	How to Update BIOS under Windows?
	IGN Module User Manual
	Intel AMT with KVM Remote Control
	POE Module User Manual
	PXE Function Manual
	RAID Function Manual
	Remote Switch Function Manual
	Wake On LAN Function Manual
WDT Function Manual	

***cincoze***

© 2024 Cincoze Co., Ltd. All rights reserved.

The Cincoze logo is a registered trademark of Cincoze Co., Ltd.

All other logos appearing in this catalog are the intellectual property of the respective company, product, or organization associated with the logo.

All product specifications and information are subject to change without notice.